



Primary switch mode power supplies CP range

ABB power supply units: CP range



Modern power supply units are a vital component in most areas of energy management and automation technology. ABB as your global partner in these areas pays the utmost attention to the resulting requirements. Innovation is the key to a substantial enlargement of our power supply product program:

CP-D

The CP-D range of power supply units in MDRC design (modular DIN rail components) fits into all domestic installation and distribution panels.

CP-E

The CP-E range offers enhanced functionality while the number of different types has been considerably reduced. Now all power supply units can be operated at an ambient temperature of up to +70 °C.

CP-T

The CP-T range of three-phase power supply units is ABB's youngest member of the power supply family.

CP-S

The CP-S range is ABB's standard range, a high-end power supply unit optimised for serial applications.

CP-C

The CP-C range's pluggable function modules adapt these power supply units exactly to your application's needs. Of course, all ABB power supply units feature primary switch mode technology – environmentally sound and cost-efficiency. This represents the highest level of innovative industrial electronics.

Application manual

For today's applications, e.g. in control engineering, it is essential to make the right decision regarding the selection and planning of the power supply unit. Incorrect dimensioning or incorrect connection of a power supply unit can seriously affect the safety and/or availability of the entire installation.

ABB's "Power Supply Units" application manual provides a general overview of switch mode power supply units, thus helping you to choose the ideal power supply unit and avoid

problems during engineering and commissioning. The manual generally shows and explains the fundamental characteristics of and the differences between power supply units, and provides a detailed introduction to the ABB product range on the basis of the selection criteria. Finally, it describes and explains application examples for engineering.

The manual is available in English and German.

English Version: 2CDC 114 048 M0202

German Version: 2CDC 114 048 M0102

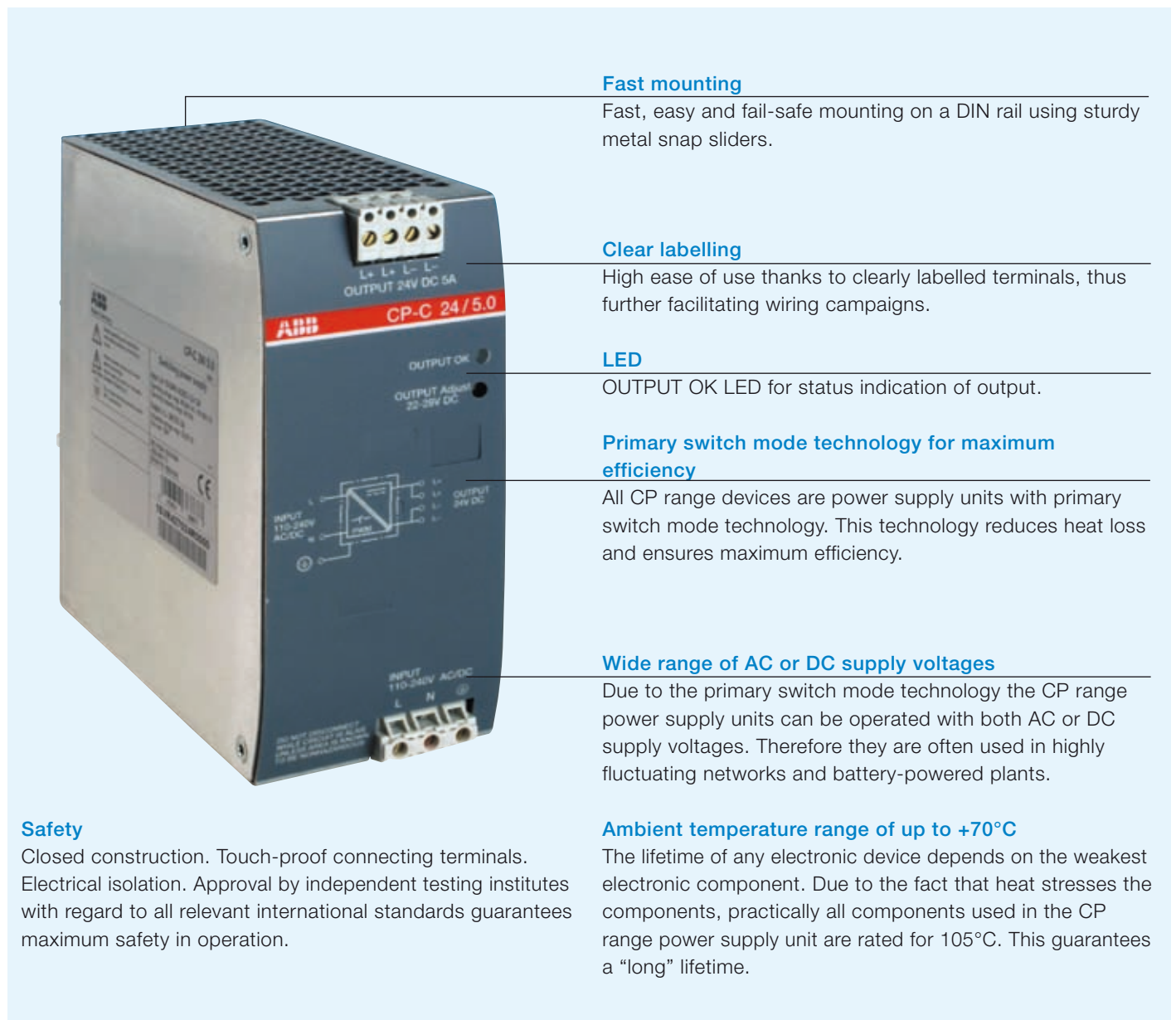

Fast mounting

Fast, easy and fail-safe mounting on a DIN rail using sturdy metal snap sliders.

Clear labelling

High ease of use thanks to clearly labelled terminals, thus further facilitating wiring campaigns.

LED

OUTPUT OK LED for status indication of output.

Primary switch mode technology for maximum efficiency

All CP range devices are power supply units with primary switch mode technology. This technology reduces heat loss and ensures maximum efficiency.

Wide range of AC or DC supply voltages

Due to the primary switch mode technology the CP range power supply units can be operated with both AC or DC supply voltages. Therefore they are often used in highly fluctuating networks and battery-powered plants.

Safety

Closed construction. Touch-proof connecting terminals. Electrical isolation. Approval by independent testing institutes with regard to all relevant international standards guarantees maximum safety in operation.

Ambient temperature range of up to +70°C

The lifetime of any electronic device depends on the weakest electronic component. Due to the fact that heat stresses the components, practically all components used in the CP range power supply unit are rated for 105°C. This guarantees a "long" lifetime.

The CP-D range power supply units



The CP-D range of modular power supply units in MDRC design (modular DIN rail components) is ideally suited for installation in distribution panels. This range offers devices with output voltages of 12 V DC and 24 V DC at output currents of 0.42 A to 4.2 A. Thanks to a high thermal efficiency corresponding to low power and heat dissipation, the devices can be operated without forced cooling. They feature the U/I output characteristic (fold forward behaviour), which makes it possible to start up loads with high inrush currents. All power supply units in the CP-D range are approved according to all relevant international standards.

Characteristics







- Output voltages 12 V, 24 V
- Adjustable output voltages (devices > 10 W)
- Output currents 0.42 A / 0.83 A / 1.3 A / 2.1 A / 2.5 A / 4.2 A
- Power range 10 W, 30 W, 60 W, 100 W
- Wide range input 100-240 V AC (90-264 V AC, 120-370 V DC)
- High efficiency of up to 89 %
- Low power dissipation and low heating
- Free convection cooling (no forced cooling with ventilators)
- Ambient temperature range during operation - 25...+70 °C
- Open-circuit, overload and short-circuit stable
- Integrated input fuse
- U/I characteristic (fold-forward behaviour at - overload – no switch-off)
- LEDs for status indication
- Light-grey enclosure in RAL 7035

Width and structural form

With a width of just 18 to 90 mm, the CP-D range switch mode power supply units are ideally suited for installation in distribution panels.

The light-grey enclosure (RAL7035) perfectly fits in with ABB's MDRC products such as RCBs and MCBs.

Approvals/marks

-  UL 508, CAN/CSA C22.2 No.14 ¹⁾
-  UL 1310, CAN/CSA C22.2 No.223 ^{1) 3)}
(Class 2 Power Supply),
-  UL 60950, CAN/CSA C22.2 No.60950 ¹⁾
-  GOST
-  CCC ¹⁾
-  CE
-  C-Tick ²⁾

¹⁾ Approvals refer to rated input voltage U_{IN}

²⁾ Pending

³⁾ Except CP-D 24/4.2

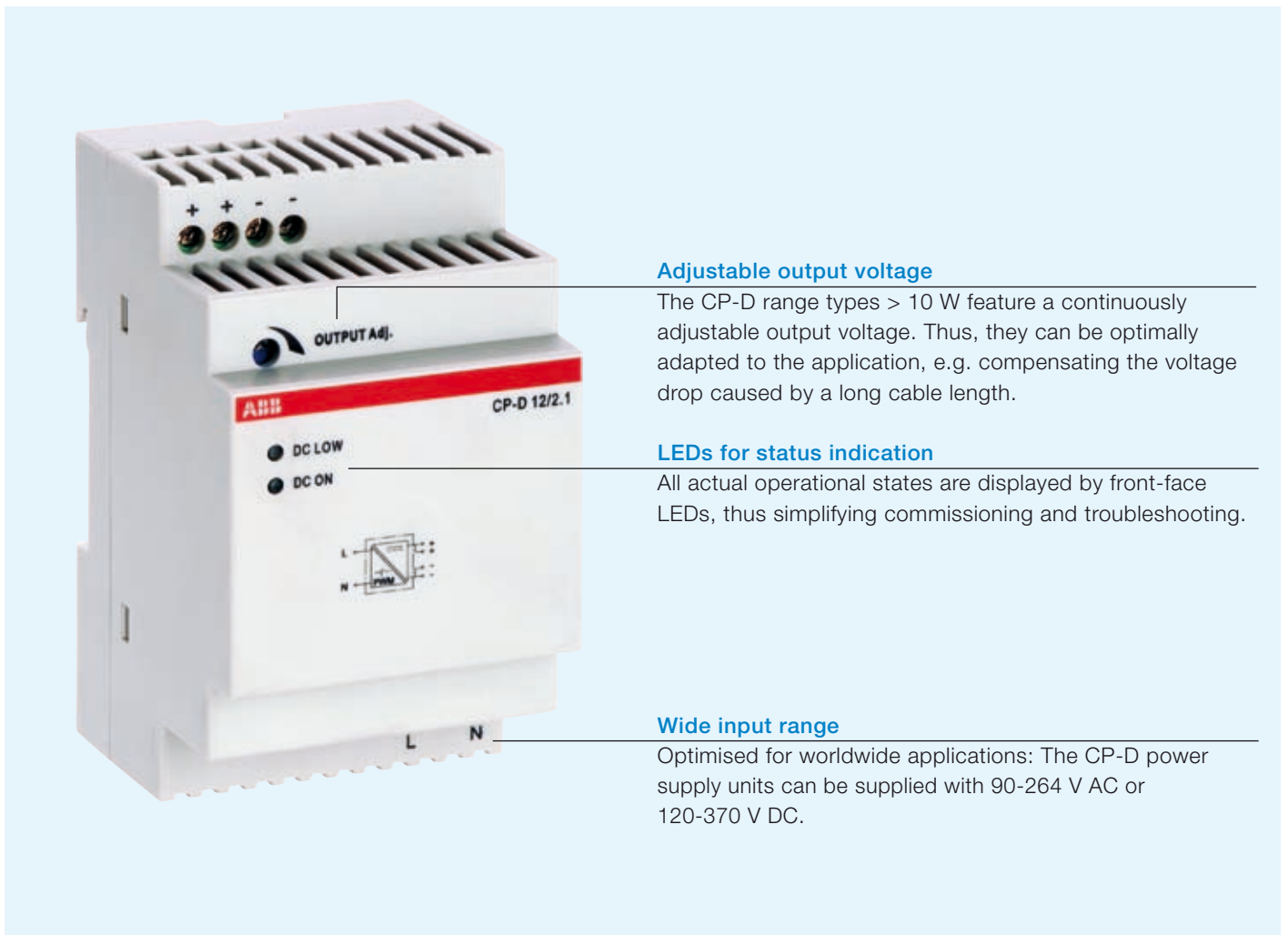

Adjustable output voltage

The CP-D range types > 10 W feature a continuously adjustable output voltage. Thus, they can be optimally adapted to the application, e.g. compensating the voltage drop caused by a long cable length.

LEDs for status indication

All actual operational states are displayed by front-face LEDs, thus simplifying commissioning and troubleshooting.

Wide input range

Optimised for worldwide applications: The CP-D power supply units can be supplied with 90-264 V AC or 120-370 V DC.

The CP-E range power supply units for standard applications



The CP-E range power supply units are an impressive addition to the ABB power supply program. This range offers types with output voltages from 5 V DC to 48 V DC at output currents of 0.625 A to 20 A. The high thermal efficiency of up to 90 %, corresponding to very low power and heat dissipation, allows operation without forced cooling. The functionality has been enhanced while the number of different types has been considerably reduced. Of course all power supplies of the CP-E range are approved in accordance with all relevant international standards.

Characteristics of the CP-E range









- Output voltage 5 V, 12 V, 24 V, 48 V DC
- Adjustable output voltages
- Output current 0.625 A / 0.75 A / 1.25 A / 2.5 A / 3 A / 5 A / 10 A / 20 A
- Power range 15 W, 18 W, 30 W, 60 W, 120 W, 240 W, 480 W
- High efficiency of up to 90 %
- Low power dissipation and low heating
- Free convection cooling (no forced cooling with ventilators)
- Ambient temperature range during operation -25... +70 °C
- Open-circuit, overload and short-circuit stable
- Integrated input fuse
- Output characteristics:
 - Hiccup-mode on CP-E 5/3.0 and CP-E 24/0.75
 - U/I characteristic curve on all other CP-E devices (fold-forward behaviour at overload – no shutdown)
- Redundancy units offering true redundancy
- LED(s) for status indication
- Signalling output/contact:
 - Transistor on 24 V devices > 18 W and < 120 W
 - Relay on 24 V devices 120 W

True redundancy and decoupling

The CP-E range power supply units are the economical solution whenever the capacity or output voltage of a power supply unit needs to be increased. Both serial and parallel connection is possible.

When it comes to decoupling parallelised power supply units < 48 V and/or decoupling issues, true redundancy can be achieved with our redundancy module CP-RUD.

Approvals/marks of the power supply units

	UL 508, CAN/CSA C22.2 No.14 ¹⁾
	UL 1310, CAN/CSA C22.2 No.223 (Class 2 Power Supply) ²⁾
	ANSI/ISA-12.12 (Class I, Div. 2 hazardous locations) ²⁾
	UL 60950, CAN/CSA C22.2 No.60950 ¹⁾
	GOST
	CCC ^{1) 2)}
	CE
	C-Tick ³⁾

¹⁾ Approvals refer to rated input voltage U_{IN}

²⁾ Except power supply units ≥ 5 A

³⁾ Available for power supply units < 5 A, pending for power supply units ≥ 5 A

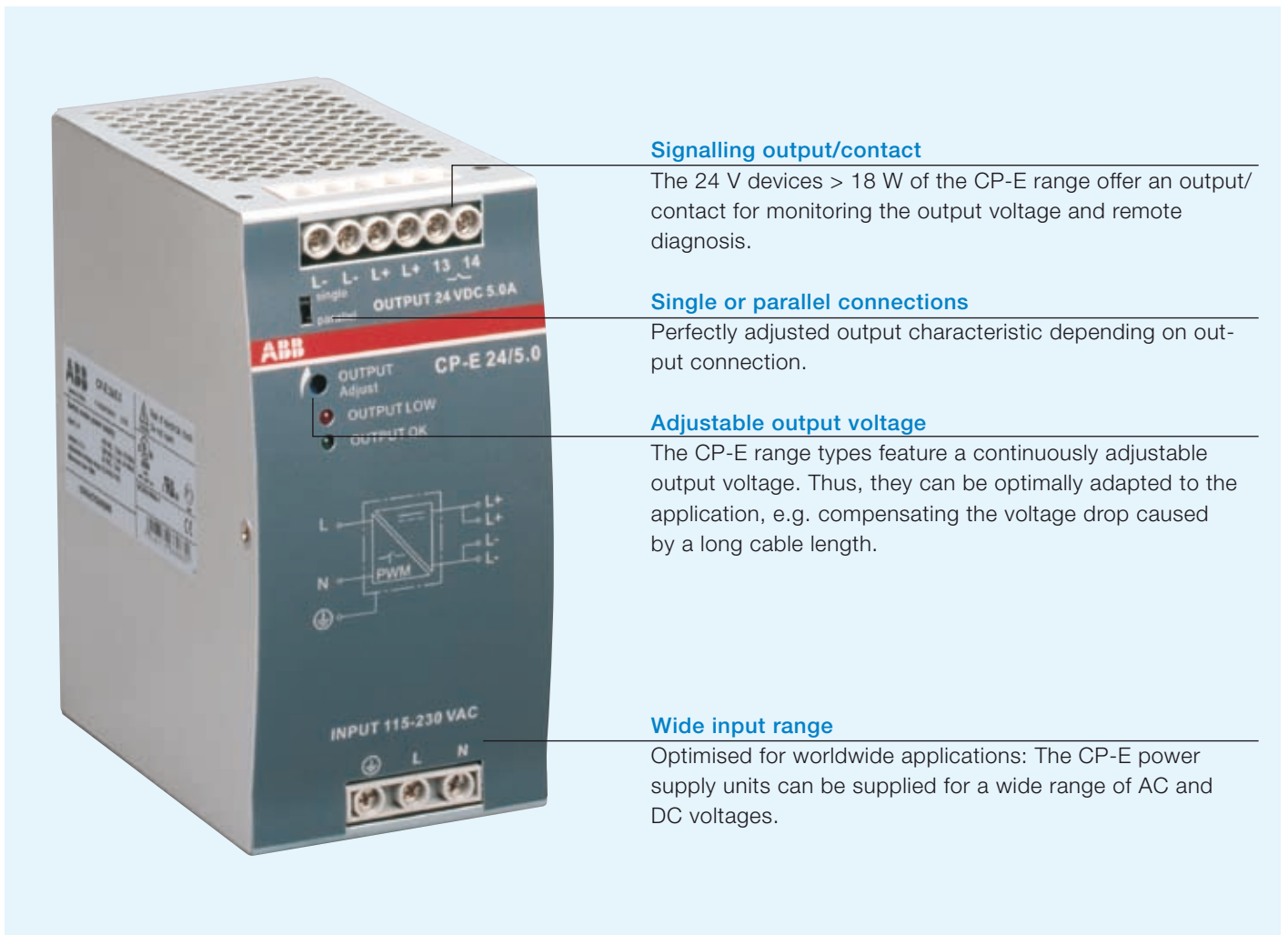

Signalling output/contact

The 24 V devices > 18 W of the CP-E range offer an output/contact for monitoring the output voltage and remote diagnosis.

Single or parallel connections

Perfectly adjusted output characteristic depending on output connection.

Adjustable output voltage

The CP-E range types feature a continuously adjustable output voltage. Thus, they can be optimally adapted to the application, e.g. compensating the voltage drop caused by a long cable length.

Wide input range

Optimised for worldwide applications: The CP-E power supply units can be supplied for a wide range of AC and DC voltages.

The proven power supply units in the CP-S and CP-C ranges



The power supply units in the CP-S and CP-C range are ABB's high-end solutions. Designed with an integrated 50 % power reserve and an efficiency of approximately 89 % these are the perfect products for all complex, highly reliable applications. All the devices cover the U-I output characteristic and are built with thermal protection which switches off in case of overheating.

In particular, the devices in the CP-C range feature have a much broader functionality, including active power factor correction and pluggable function modules.

Characteristics

- Output current 5 A, 10 A and 20 A
- Integrated power reserve of up to 50 %
- High efficiency of approx. 89 %
- Low power dissipation and low heating
- Open-circuit, overload and short-circuit stable, automatic recovery
- Integrated input fuse
- Redundancy unit CP-A RU offering true redundancy
- Control module (voting unit) CP-A CM pluggable onto CP-A RU
- Pluggable output terminals for up to 10 A
- Status LED "OUTPUT OK"

CP-S

- Wide input range of 110-240 V AC (85-264 V AC, 100-350 V DC) 5 A version
- Input voltage adjustable via front-face selector switch (10 A, 20 A version)
- Output voltage fixed at 24 V DC
- Parallel operation for redundancy

CP-C

- Wide input range of 110-240 V AC (85-264 V AC, 100-350 V DC)
- Output voltage adjustable in a range of 22-28 V DC
- Parallel operation for increased capacity and redundancy
- Power factor correction (PFC) in accordance with EN 61000-3-2
- Function module CP-C MM pluggable onto the front side

State-of-the-art technology

Integrated power reserve:

The CP-S and CP-C range power supply units feature an integrated power reserve of up to 50 %. No oversized electricity supply is needed, especially under heavy load conditions.

U-I characteristic:

Perfect performance in case of overload or short-circuit. The current does not sag in the case of overload; this method allows reliable starting of high loads.

Active power factor correction:

Fully compliant with EN61000-3-2, the CP-C range avoids almost every kind of harmonics.

Approvals/marks of the power supply units



UL 508, CAN/CSA C22.2 No.14 ¹⁾



UL 1604 (Class I, Div. 2, hazardous locations)
CAN/CSA C22.2 No.213¹⁾,



UL 60950, CAN/CSA C22.2 No.60950 ¹⁾



GOST,



CB scheme



^{1) 2)}



C-Tick

¹⁾ Approvals refer to rated input voltage U_{IN}

²⁾ Not for CP-S 24/10.0 and CP-S 24/20.0



Double terminal assignment

The double assignment of the output terminals considerably reduces the amount of wiring by eliminating the need for potential multiplication.

Adjustable output voltage

The CP-C range types feature a continuously adjustable output voltage. Thus, they can be optimally adapted to the application, e.g. compensating the voltage drop caused by a long line length.

Pluggable function modules

The CP-C range power supply units can be equipped with the pluggable module CP-C MM to add specific functions. The result is a superior price/performance ratio and a future-proof solution for maximum flexibility without any sacrifices to user comfort.

Pluggable terminals

Extended flexibility in operation due to pluggable output terminals (this feature is not offered on all devices).

Messaging module

Messaging module CP-C MM is designed to indicate the input and output status and can be used to switch the power supply unit on or off via remote control.

The new three-phase power supplies CP-T range



The CP-T range of three-phase power supply units is the youngest member of ABB's power supply family. In terms of design and functionality, the new range perfectly supplements the existing products and extends the range appropriately. The devices can be supplied with a three-phase voltage as well as with two-phase mains. Here, ABB offers power supply units with 24 V DC and 48 V DC outputs with 5 A, 10 A, 20 A and 40 A and efficiency of up to 92 %. As in the case of all products, they are designed for an ambient temperature of up to 70 °C.









Characteristics of the CP-T range

- Rated output voltage 24 V DC or 48 V DC
- Output voltage adjustable via front-face rotary potentiometer "OUTPUT Adjust"
- Rated output current 5 A / 10 A / 20 A / 40 A
- Rated output power 120 W / 240 W / 480 W / 960 W
- Supply range 3 x 400-500 V AC (3 x 340-575 V AC, 480-820 V DC)
- Two-phase supply with a derating of the output to 75 % possible / permitted
- Typical efficiency of 89 %
- Low power dissipation and low heating
- Free convection cooling (no forced cooling with ventilators)
- Ambient temperature range during operation -25... +70 °C
- Open-circuit, overload and short-circuit stable
- Integrated input fuse
- Redundancy unit CP-A RU offering true redundancy, available as accessory
- Signalling contact "13-14" (Relay) for output voltage OK

Completion of product range

The CP-T range completes ABB's high-class power supply units. ABB now offers devices in a very wide range for nearly all kinds of applications: in MDRC (CP-D) design, for serial applications (CP-E), for high performance (CP-S and CP-C) as well as for three-phase and two-phase applications. The current product portfolio is constantly adapted to the market demand and the requirements of our customers.

Approvals/marks of the power supply units

	UL 508, CAN/CSA C22.2 No.14 ¹⁾
	UL 1310, CAN/CSA C22.2 No.223 (Class 2 Power Supply) ²⁾ ,
	ANSI/ISA-12.12 (Class I, Div. 2 hazardous locations) ²⁾
	UL 60950, CAN/CSA C22.2 No.60950 ¹⁾
	
	GOST
	CB scheme
	CCC ^{1) 2)}
	C-Tick ³⁾

¹⁾ Approvals refer to rated input voltage U_{IN}

²⁾ Except power supply units ≥ 5 A

³⁾ Available for power supply units < 5 A, pending for power supply units ≥ 5 A



Signalling output

A relay output indicates the error-free operation of the output voltage.

Adjustable output voltage

The CP-T range types feature a continuously adjustable output voltage. Thus, they can be optimally adapted to the application, e.g. compensating the voltage drop caused by a long cable length.

Wide input range

Optimised for worldwide applications: The CP-T power supply units can be supplied for a wide range of AC and DC voltages. Both kinds of power supply (three-phase and two-phase) are possible.

CP range auxiliaries

Redundancy module to establish true redundancy

Redundancy module CP-A RU

Characteristics

- For CP-S, CP-C, CP-T and CP-E power supply units
- For decoupling of parallelised power supply units, allowing true redundancy can be achieved
- 2 inputs, each up to 20 A
- Output up to 40 A
- 2 integrated diodes for decoupling
- Control module CP-A CM can be mounted on the front of the unit (accessory)



Control module CP-A CM

Characteristics

- Plugs onto the redundancy unit CP-A RU to allow the voltage to be monitored in each channel of the CP-A RU
- Adjustable threshold values (14-28 V) and one relay output per input/circuit



Application example

- Implementation of a 2-way redundant power supply unit
- Monitoring of the input voltages of both power supply units
- Relay outputs for separate signalling of faults

In the event of a fault on the secondary/load side (e.g. with a short-circuit on the load side of a power supply unit or the failure of a power supply unit), the CP-A RU decouples the second power supply unit from this fault. This prevents the fault from producing a short-circuit on the output of the intact power supply unit and guarantees a continued interruption-free supply to the load. It is recommended to power both power supply units on different phases to ensure that neither of them are disconnected from the mains supply in the event of a fault on the primary/supply side (e.g. should the common primary fuse for both supply units trip due to a short-circuit).

The CP-A CM monitors the voltages of both connected power supply units applied to the CP-A RU. If the voltage of one or both power supply units drops below the set threshold value (e.g. 20 V), the corresponding relay of the CP-A CM will de-energise. Possible causes for the de-energisation of one or both relays:

- A power supply unit has failed or is switched off
- Both power supply units have failed or are switched off
- The secondary side is subject to overload

A brief de-energisation of one or both relays indicates that the connected load has returned to normal rated operation after power-up.

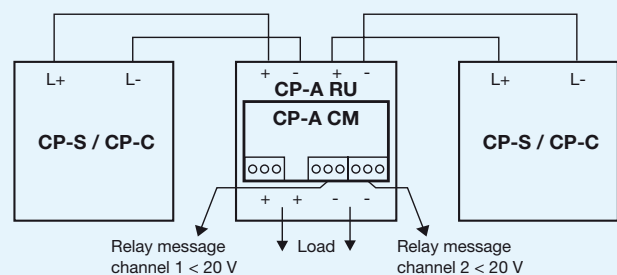

2CDC 272 028 F0205

Primary switch mode power supplies CP-D, CP-E, CP-S/C, CP-T range



Environment protection thanks to modern technology

- The ABB power supplies of the CP-D, CP-E, CP-S, CP-C and CP-T range also persuade unconfined in consideration of effective and sustainable environment protection. This is because their primary switch mode design does not only stand for outstanding efficiency but also for a noteworthy relief of the environment.
- Power supplies with primary switch mode are characterised by their exceptional efficiency of up to 89 %: A remarkable difference to conventional power supplies that often only operate with 50 % efficiency.

High efficiency of up to 89 %

- The high efficiency of the ABB power supplies means that only 10-12 % of the input energy are lost in dissipated heat.
- Thanks to the low dissipated heat, other advantages result. For example it is often possible to dispense with costly extern cooling systems when the power supplies are used in cabinets.
- Also, the ABB power supplies with primary switch mode feature an outstanding durability. This improves the operating efficiency and means further relief of the environment.

Reliability in different environments

- Due to their reliable construction, the CP-D, CP-E, CP-S, CP-C and CP-T range power supplies can be used in very harsh environments.
- Adherence to electrical safety standards makes these power supplies very safe and well-suited for industrial equipment while also allowing their use in domestic applications, wherever automation is important.
- The wide AC/DC range of input power makes these power supplies very flexible and offers a perfect solution for DC networks, power failure back-up systems, and much more.
- The pluggable function module of the CP-C range power supplies allow a perfect adaptation for special application needs.
- Adjustable output voltage compensates for drops in the DC power line.

Approvals provide high safety

- Applicability of the most important approvals and the observance of the valid EU standards provide high safety when using the power supply.
- High interference immunity combined with reduced interference emission acc. to EN 61000-6-4 enable the use in rough industrial environments as well for building installations.

Product selection table



		Single-phase																		
		CP-D						CP-E												
		0.42 A	0.83 A	1.3 A	2.1 A	2.5 A	4.2 A	0.625 A	0.75 A	1.25 A	2.5 A	3 A	5 A	10 A	20 A					
Rated output voltage	5 V DC																			
	12 V DC		•		•						•						•			
Rated output power/voltage	24 V DC	•		•		•	•		•	•		•			•			•		
	48 V DC							•			•									
	10 W																			
	15 W		•																	
	18 W	•								•										
	30 W											•								
	60 W																			
	100 W																			
	120 W																			
	240 W																			
Rated input voltage	48 V DC																			
	24 V DC																			
	48 V DC																			
	960 W																			
Rated input voltage	100-240 V AC	•	•	•	•	•	•	•	•	•	•	•								
	115/230 V AC auto select																			
	115-230 V AC																			
	110-240 V AC																			
	110-120 V AC																			
	220-240 V AC																			
Accessories	400-500 V AC																			
	Redundancy Module								•	•	•	•	•	•	•	•	•	•		
	Control Module																			
	Messaging Module																			
	Order code	1SVR427041R0000	1SVR427041R1000	1SVR427043R0100	1SVR427043R1200	1SVR427044R0200	1SVR427045R0400	1SVR427030R2000	1SVR427030R0000	1SVR427031R0000	1SVR427031R2000	1SVR427032R1000	1SVR427032R0000	1SVR427033R3000	1SVR427034R0000	1SVR427034R2000	1SVR427035R1000	1SVR427035R0000	1SVR427035R2000	1SVR427036R0000



		Rated output current	Single-phase						Three-phase					
			CP-S			CP-C			CP-T					
			5 A	10 A	20 A	5 A	10 A	20 A	5 A	10 A	20 A	40 A		
Rated output voltage		5 V DC												
		12 V DC												
		24 V DC	•	•	•	•	•	•	•	•	•	•		
		48 V DC							•	•	•			
Rated output power/voltage	10 W	12 V DC												
		24 V DC												
	15 W	5 V DC												
		24 V DC												
	18 W	12 V DC												
		24 V DC												
	30 W	12 V DC												
		24 V DC												
	60 W	48 V DC												
		24 V DC												
	100 W	48 V DC												
		24 V DC												
	120 W	12 V DC												
		24 V DC	•			•			•					
	240 W	24 V DC		•			•			•				
		48 V DC							•	•				
480 W	24 V DC			•			•			•				
	48 V DC								•					
960 W	24 V DC										•			
	48 V DC									•				
Rated input voltage	100-240 V AC													
	115/230 V AC auto select													
	115-230 V AC													
	110-240 V AC	•			•	•	•							
	110-120 V AC		•	•										
	220-240 V AC		•	•										
Accessories	400-500 V AC							•	•	•	•			
	Redundancy Module	•	•	•	•	•	•	•	•	•	•			
	Control Module	•	•	•	•	•	•							
	Messaging Module				•	•	•							
	Order code	1SVR427014R0000	1SVR427015R0100	1SVR427016R0100	1SVR427024R0000	1SVR427025R0000	1SVR427026R0000	1SVR427054R0000	1SVR427054R2000	1SVR427055R0000	1SVR427055R2000	1SVR427056R0000	1SVR427056R2000	1SVR427057R0000

Switch mode Power supplies



Switch mode power supplies

CP-D, CP-E, CP-T, CP-S

CP-C, CP-A, CP-B

Electronic protection device

EPD24

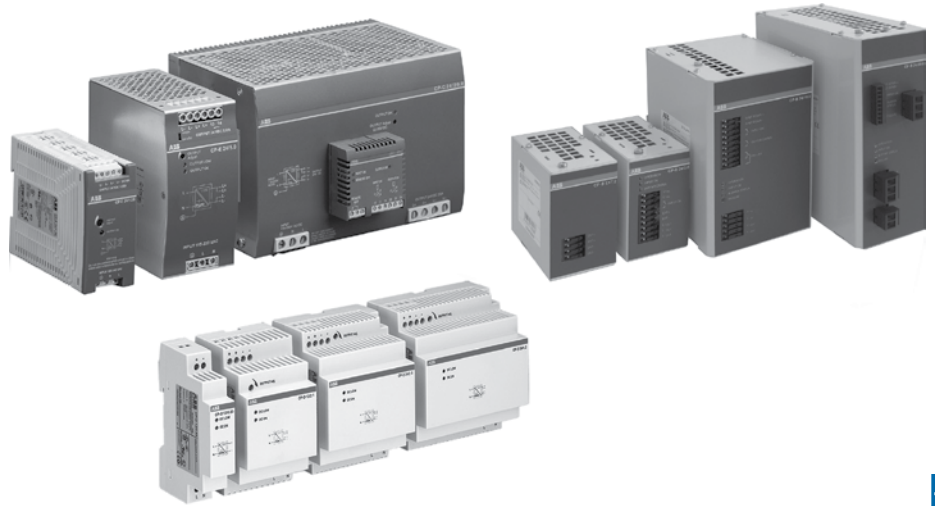

Special features of CP range primary switch power supplies

- Primary switch mode power supplies
 - High efficiency of approx. 90 %
 - Low power dissipation and low heating
 - Long lifetime
- Wide range of AC or DC supply voltages
 - World wide use also in high fluctuating networks and battery-powered plants
- Constant or adjustable output voltage (depending on type)
- Use in very harsh industrial environments
 - Reliable construction
 - According to EMC Directives EN 61000-6-2 (Interference immunity) & EN 61000-6-4 (Interference emission)
- Open-circuit, overload and short-circuit proof
- Integrated input fuse
- Safety
 - Closed construction
 - Touch-proof connecting terminals
 - Electrical isolation
- Easy and fast mounting
 - Mounting on DIN rail
- LED(s) for status indication
- Example of application
 - Supply of programmable logic controllers (PLC), e. g. AC31, AC500

Selection table

		CP-D						CP-E						CP-T						CP-S			CP-C					
Rated output current (Amps)		0.42	0.83	1.3	2.1	2.5	4.2	0.625	0.75	1.25	2.5	3	5	10	20	5	10	20	40	5	10	20	5	10	20	5	10	20
Rated output voltage	5 V DC																											
	12 V DC		■									■																
	24 V DC	■		■									■															
	48 V DC						■																					
10 W	12 V DC		■																									
	24 V DC	■																										
15 W	5 V DC											■																
18 W	24 V DC								■																			
30 W	12 V DC				■																							
	24 V DC			■						■																		
	48 V DC						■																					
60 W	24 V DC					■																						
	48 V DC									■																		
100 W	24 V DC						■																					
120 W	12 V DC																											
	24 V DC											■																
240 W	24 V DC												■															
	48 V DC												■															
480 W	24 V DC																											
	48 V DC													■														
960 W	24 V DC																											
	48 V DC																											
Rated input voltage	100-240 V AC	■	■	■	■	■	■	■	■	■	■	■	■	■	■	■	■	■	■	■	■	■	■	■	■	■	■	■
	115 / 230 V AC auto select												■	■	■													
	115-230 V AC													■	■													
	110-240 V AC																											
	110-120 V AC																											
	220-240 V AC																											
400-500 V AC																												
Accessories	Redundancy unit	■	■	■	■	■	■	■	■	■	■	■	■	■	■	■	■	■	■	■	■	■	■	■	■	■	■	■
	Control module																											
	Messaging module																											
Structure of the type designation	CP-x y/z.z CP: Power supply x: Product range y: Rated output voltage z: Rated output current																											

Approvals and marks

		CP-D						
		CP-D 12/0.83	CP-D 12/2.1	CP-D 24/0.42	CP-D 24/1.3	CP-D 24/2.5	CP-D 24/4.2	CP-D RU
■ existing □ pending								
Approvals								
	UL 508, CAN/CSA C22.2 No.14	■ ¹⁾	■ ¹⁾	■ ¹⁾	■ ¹⁾	■ ¹⁾	■ ¹⁾	
	UL 1310, CAN/CSA C22.2 No.223 (Class 2 Power Supply)	■ ¹⁾	■ ¹⁾	■ ¹⁾	■ ¹⁾	■ ¹⁾		
	UL 60950, CAN/CSA C22.2 No.60950	■ ¹⁾	■ ¹⁾	■ ¹⁾	■ ¹⁾	■ ¹⁾	■ ¹⁾	
	GOST	■	■	■	■	■	■	
	CCC	■ ¹⁾	■ ¹⁾	■ ¹⁾	■ ¹⁾	■ ¹⁾	■ ¹⁾	
Marks								
	CE	■	■	■	■	■	■	■
	C-Tick	□	□	□	□	□	□	

		CP-E													CP-T									
		CP-E 5/3.0	CP-E 12/2.5	CP-E 12/10.0	CP-E 24/0.75	CP-E 24/1.25	CP-E 24/2.5	CP-E 24/5.0	CP-E 24/10.0	CP-E 24/20.0	CP-E 48/0.62	CP-E 48/1.25	CP-E 48/5.0	CP-E 48/10.0	CP-RUD	CP-T 24/5.0	CP-T 24/10.0	CP-T 24/20.0	CP-T 24/40.0	CP-T 48/5.0	CP-T 48/10.0	CP-T 48/20.0		
■ existing □ pending																								
Approvals																								
	UL 508, CAN/CSA C22.2 No.14	■ ¹⁾	■ ¹⁾	■ ¹⁾	■ ¹⁾	■ ¹⁾	■ ¹⁾	■ ¹⁾	■ ¹⁾	■ ¹⁾	■ ¹⁾	■ ¹⁾	■ ¹⁾	■ ¹⁾	■ ¹⁾	■ ¹⁾	■ ¹⁾	■ ¹⁾	■ ¹⁾	■ ¹⁾	■ ¹⁾	■ ¹⁾	■ ¹⁾	■ ¹⁾
	UL 1310, CAN/CSA C22.2 No.223 (Class 2 Power Supply)	■	■		■	■	■				■	■												
	ANSI/ISA-12.12 (Class I, Div. 2, hazardous locations) CAN/CSA C22.2 No. 213	■	■	■	■	■	■	■	■	■	■	■	■	■	■	■	■	■	■	■	■	■	■	■
	UL 60950, CAN/CSA C22.2 No.60950	■ ¹⁾	■ ¹⁾	■ ¹⁾	■ ¹⁾	■ ¹⁾	■ ¹⁾	■ ¹⁾	■ ¹⁾	■ ¹⁾	■ ¹⁾	■ ¹⁾	■ ¹⁾	■ ¹⁾	■ ¹⁾	■ ¹⁾	■ ¹⁾	■ ¹⁾	■ ¹⁾	■ ¹⁾	■ ¹⁾	■ ¹⁾	■ ¹⁾	■ ¹⁾
	GOST	■	■	■	■	■	■	■	■	■	■	■	■	■	■	■	■	■	■	■	■	■	■	■
	CCC	■ ¹⁾	■ ¹⁾	■ ¹⁾	■ ¹⁾	■ ¹⁾	■ ¹⁾	■ ¹⁾	■ ¹⁾	■ ¹⁾	■ ¹⁾	■ ¹⁾	■ ¹⁾	■ ¹⁾	■ ¹⁾	■ ¹⁾	■ ¹⁾	■ ¹⁾	■ ¹⁾	■ ¹⁾	■ ¹⁾	■ ¹⁾	■ ¹⁾	■ ¹⁾
Marks																								
	CE	■	■	■	■	■	■	■	■	■	■	■	■	■	■	■	■	■	■	■	■	■	■	■
	C-Tick	■	■	■	■	■	■	■	■	■	■	■	■	■	■	■	■	■	■	■	■	■	■	■

		CP-S			CP-C			CP-A	CP-B					
		CP-S 24/5.0	CP-S 24/10.0	CP-S 24/20.0	CP-C 24/5.0	CP-C 24/10.0	CP-C 24/20.0	CP-C MM	CP-A RU	CP-A CM	CP-B 24/3.0	CP-B 24/10.0	CP-B 24/20.0	CP-B EXT.2
■ existing □ pending														
Approvals														
	UL 508, CAN/CSA C22.2 No.14	■ ¹⁾	■ ¹⁾	■ ¹⁾	■ ¹⁾	■ ¹⁾	■ ¹⁾				■	■	■	■
	UL 508, CAN/CSA C22.2 No.14								□					
	UL 1604 (Class I, Div. 2, hazardous locations), CAN/CSA C22.2 No.213	■ ¹⁾	■ ¹⁾	■ ¹⁾	■ ¹⁾	■ ¹⁾	■ ¹⁾							
	UL 60950, CAN/CSA C22.2 No.60950	■ ¹⁾	■ ¹⁾	■ ¹⁾	■ ¹⁾	■ ¹⁾	■ ¹⁾	■ ¹⁾	■ ¹⁾					
	GOST	■	■	■	■	■	■	■	■	■	■	■	■	■
	CB scheme	■	■	■	■	■	■	■	■					
Marks														
	CE	■	■	■	■	■	■	■	■	■	■	■	■	■
	C-Tick	■	■	■	■	■	■	■	■	□				

¹⁾ Approvals refer to the rated input voltage U_{in}.



Type CP-D Switch mode Power supplies



Characteristics

- Output voltages 12 V, 24 V DC
- Adjustable output voltages (devices > 10 W)
- Output currents 0.42 A / 0.83 A / 1.3 A / 2.1 A / 2.5 A / 4.2 A
- Power range 10 W, 30 W, 60 W, 100 W
- Wide range input 100-240 V AC (90-264 V AC, 120-375 V DC)
- High efficiency of up to 89 %
- Low power dissipation and low heating
- Free convection cooling (no forced cooling with ventilators)
- Ambient temperature range during operation -40°C...+70 °C
- Open-circuit, overload and short-circuit stable
- Integrated input fuse
- U/I characteristic (fold-forward behavior at overload – no switch-off)
- LEDs for status indication
- Light-grey housing
- Approvals / Marks (depending on device, partly pending):



Benefits

Width and structural form ①

With their width between 18 and 90 mm, the CP-D range switch mode power supplies are ideally suited for installation in distribution panels.

Wide range input ②

Optimized for world-wide applications: The CP-D power supplies can be supplied with 90-264 V AC or 120-375 V DC.

Adjustable output voltage ③

The CP-D range types > 10 W feature a continuously adjustable output voltage. Thus, they can be optimally adapted to the application, e.g. compensating the voltage drop caused by a long line length.

CP-D Range Ordering details

Description

The CP-D range of modular power supply units in MDRC design (modular DIN rail components) is ideally suited for installation in distribution panels. This range offers devices with output voltages of 12 V DC and 24 V DC at output currents of 0.42 A to 4.2 A. Thanks to a high thermal efficiency corresponding to low power and heat dissipation, the devices can be operated without forced cooling. All devices feature the U/I output characteristic (fold forward behavior). All power supply units in the CP-D range are approved according to all relevant international standards.



CP-D 12/0.83, CP-D 24/0.42



CP-D 12/2.1, CP-D 24/1.3



CP-D 24/2.5

Ordering details

Input voltage range	Rated output voltage / current	Type	Catalog number	Weight (1 pce) kg (lb)
90-264 V AC/ 120-375 V DC	12 V DC / 0.83 A	CP-D 12/0.83	1SVR427041R1000	0.06 (0.13)
90-264 V AC/ 120-375 V DC	12 V DC / 2.1 A	CP-D 12/2.1	1SVR427043R1200	0.19 (0.41)
90-264 V AC/ 120-375 V DC	24 V DC / 0.42 A	CP-D 24/0.42	1SVR427041R0000	0.06 (0.13)
90-264 V AC/ 120-375 V DC	24 V DC / 1.3 A	CP-D 24/1.3	1SVR427043R0100	0.19 (0.41)
90-264 V AC/ 120-375 V DC	24 V DC / 2.5 A	CP-D 24/2.5	1SVR427044R0200	0.25 (0.56)
90-264 V AC/ 120-375 V DC	24 V DC / 4.2 A	CP-D 24/4.2	1SVR427045R0400	0.32 (0.71)

Ordering details - CP-D RU for decoupling of two CP-D power supply units

Input voltage range	Rated input current	Rated output voltage / current	Type	Catalog number	Weight (1 pce) kg (lb)
9-35 V DC	2 x 5 A	24 V DC / 1 x 10 A	CP-D RU	1SVR427049R0000	0.075 (0.165)

CP-D Range

Technical data

Data at $T_a = 25\text{ °C}$, $U_n = 230\text{ V AC}$ and rated values, unless otherwise indicated

Type		CP-D 12/0.83	CP-D 12/2.1
Input circuit - supply circuit		L, N	
Rated input voltage U_n		100-240 V AC	
Input voltage range		90-264 V AC / 120-375 V DC	
Frequency range AC		47-63 Hz	
Typical input current / typical power consumption	at 110 V AC	200 mA / 12.68 W	502 mA / 31.14 W
	at 230 V AC	128.3 mA / 13.01 W	277 mA / 31.2 W
Inrush current limiting	at 230 V AC	30 A (max. 3 ms)	50 A (max. 3 ms)
Power failure buffering time		min. 30 ms	
Internal input fuse		1 A slow-acting / 250 V AC	2 A slow-acting / 250 V AC
Power factor correction (PFC)		no	
Indication of operational states			
Output voltage	DC ON: green LED DC LOW: red LED		output voltage applied output voltage too low
Output circuit		+, -	++, --
Rated output voltage		12 V DC	
Tolerance of the output voltage		$\pm 1\%$	
Adjustment range of the output voltage		-	12-14 V DC
Rated output power		10 W	30 W
Rated output current I_r	$T_a \leq 60\text{ °C}$	0.83 A	2.1 A
Derating of the output current	$60\text{ °C} < T_a \leq 70\text{ °C}$	2.5 %/°C	
Maximum deviation with change of output voltage within the input voltage range	load change statical	1 %	
Control time		1 %	
Starting time after applying the supply voltage	at I_r	< 1 ms	
Rise time	at rated load	1000 ms	
Residual ripple and switching peaks	BW = 20 MHz	typ. 1 ms	
Parallel connection		50 mV	
Series connection		yes, using CP-D RU	
Resistance to reverse feed		yes, to increase voltage	
		18 V / 1 s	
Output circuit - No-load, overload and short-circuit behavior			
Characteristic curve of output		U/I characteristic curve	
Short-circuit protection		continuous short-circuit stability	
Short-circuit behavior		continuation with output power limiting	
Current limiting at short circuit		typ. 1.4 A	typ. 5.9 A
Overload protection		output power limiting	
Overvoltage protection		15-16.5 VDC	
No-load protection		continuous no-load stability	
Starting of capacitive loads		unlimited	
General data			
Efficiency		typ. 78 %	typ. 82 %
Duty time		100 %	
Dimensions (W x H x D)		18 x 91 x 57.5 mm [0.71 x 3.58 x 2.26 in]	53 x 91 x 57.5 mm [2.09 x 3.58 x 2.26 in]
Weight		0.066 kg (0.13 lb)	0.196 kg (0.41 lb)
Material of housing		plastic	
Mounting		DIN rail (IEC/EN 60715), snap-on mounting without any tool	
Mounting position		horizontal	
Minimum distance to other units	horizontal / vertical	25 mm / 25 mm (0.98 in / 0.98 in)	
Degree of protection	housing / terminals	IP20 / IP20	
Protection class		II	

CP-D Range Technical data

Data at $T_a = 25\text{ °C}$, $U_n = 230\text{ V AC}$ and rated values, unless otherwise indicated

Type		CP-D 12/0.83	CP-D 12/2.1
Electrical connection - Input circuit / Output circuit			
Wire size	fine-strand with wire end ferrule	0.2-1.5 mm ² (24-16 AWG)	0.2-2.5 mm ² (24-14 AWG)
	rigid	0.2-2.5 mm ² (26-12 AWG)	0.2-2.5 mm ² (24-12 AWG)
Stripping length		4-5 mm (0.16-0.2 in)	7 mm (0.28 in)
Tightening torque		0.6 Nm (5 lb.in)	0.7 Nm (6 lb.in)

Environmental data

Ambient temperature range	operation	-40...+70 °C	
	rated load	-40...+60 °C	
	storage	-40...+85 °C	
Damp heat (cyclic) (IEC/EN 60068-2-30)		4 x 24 cycles, 40 °C, 95 % RH	
Vibration (sinusoidal) (IEC/EN 60068-2-6)		50 m/s ² , 10 Hz - 2 kHz	
Shock (half-sine) (IEC/EN 60068-2-27)		40 m/s ² , 22 ms	

Isolation data

Rated insulation voltage U_i	input circuit / output circuit	3 kV AC	
Pollution degree		2	
Overvoltage category (UL/IEC/EN 60950-1)		II	

Standards

Product standard		EN 61204	
Low Voltage Directive		2006/95/EC	
EMC Directive		2004/108/EC	
Electrical safety		UL 508, UL 60950-1, EN 60950-1	
Protective low voltage		SELV (EN 60950-1)	

Electromagnetic compatibility

Interference immunity to		EN 61000-6-2	
electrostatic discharge	IEC/EN 61000-4-2	Level 4 (4 kV / 8 kV)	Level 4 (8 kV / 15 kV)
radiated, radio-frequency, electromagnetic field	IEC/EN 61000-4-3	Level 3 (10 V/m)	
electrical fast transient/burst	IEC/EN 61000-4-4	Level 4 (4 kV)	
surge	IEC/EN 61000-4-5	Level 3 (2 kV L-L)	
conducted disturbances, induced by radio-frequency fields	IEC/EN 61000-4-6	Level 3 (10 V)	
Interference emission		EN 61000-6-3	
high-frequency radiated	IEC/CISPR 22, EN 55022	Class B	
high-frequency conducted	IEC/CISPR 22, EN 55022	Class B	

Approvals and marks on page 11.3.

CP-D Range

Technical data

Data at $T_a = 25\text{ °C}$, $U_{in} = 230\text{ V AC}$ and rated values, unless otherwise indicated

Type	CP-D 24/0.42	CP-D 24/1.3	CP-D 24/2.5	CP-D 24/4.2
Input circuit - supply circuit	L, N			
Rated input voltage U_{in}	100-240 V AC			
Input voltage range	90-264 V AC / 120-375 V DC			
Frequency range AC	47-63 Hz			
Typical input current / typical power consumption	at 110 V AC 184 mA / 11.62 W	600 mA / 37.92 W	1120 mA / 69.3 W	1800 mA / 117.3 W
	at 230 V AC 120.6 mA / 12 W	344 mA / 38.16 W	660 mA / 70.1 W	900 mA / 114.4 W
Inrush current limiting	at 230 V AC 30 A (max. 3 ms)		50 A (max. 3 ms) / 60 A (max. 3 ms)	
Power failure buffering time	min. 30 ms		min. 60 ms	
Internal input fuse	1 A slow-acting / 250 V AC	2 A slow-acting / 250 V AC		3.15 A slow-acting / 250 V AC
Power factor correction (PFC)	no			

Indication of operational states

Output voltage	DC ON: green LED DC LOW: red LED	output voltage applied output voltage too low		
Output circuit		+, -	++, --	
Rated output voltage		24 V DC		
Tolerance of the output voltage		±1 %		
Adjustment range of the output voltage		-	24-28 V DC	
Rated output power		10 W	30 W	60 W
Rated output current I_o		$T_a \leq 60\text{ °C}$: 0.42 A	$T_a \leq 60\text{ °C}$: 1.3 A	$T_a \leq 55\text{ °C}$: 2.5 A
Derating of the output current		$60\text{ °C} < T_a \leq 70\text{ °C}$: 2.5 %/°C	$60\text{ °C} < T_a \leq 70\text{ °C}$: 2.5 %/°C	$55\text{ °C} < T_a \leq 70\text{ °C}$: 2.5 %/°C
Maximum load change statical deviation with change of output voltage within the input voltage range		1 %		
Control time		< 1 ms		
Starting time after applying the supply voltage	at I_o	1000 ms		
Rise time	at rated load	typ. 1 ms		
Residual ripple and switching peaks	BW = 20 MHz	50 mV		
Parallel connection		yes, using CP-D RU		
Series connection		yes, to increase voltage		
Resistance to reverse feed		35 V / 1 s		

Output circuit - No-load, overload and short-circuit behavior

Characteristic curve of output		U/I characteristic curve		
Short-circuit protection		continuous short-circuit stability		
Short-circuit behavior		continuation with output power limiting		
Current limiting at short circuit		typ. 0.78 A	typ. 4.2 A	typ. 6.05 A
Overload protection		typ. 11.5 A		
Overvoltage protection		output power limiting		
No-load protection		30-33 V DC		
Starting of capacitive loads		continuous no-load stability		
		unlimited		

General data

Efficiency		typ. 80 %	typ. 83 %	typ. 86 %	typ. 89 %
Duty time		100 %			
Dimensions (W x H x D)		18 x 91 x 57.5 mm [0.71 x 3.58 x 2.26 in]	53 x 91 x 57.5 mm [2.09 x 3.58 x 2.26 in]	71 x 91 x 57.5 mm [2.80 x 3.58 x 2.26 in]	89.9 x 91 x 57.5 mm [3.54 x 3.58 x 2.26 in]
Weight		0.066 kg (0.13 lb)	0.196 kg (0.41 lb)	0.252 kg (0.55 lb)	0.386 kg / (0.72 lb)
Material of housing		plastic			
Mounting		DIN rail (IEC/EN 60715), snap-on mounting without any tool			
Mounting position		horizontal			
Minimum distance to other units	horizontal / vertical	25 mm / 25 mm (0.98 in / 0.98 in)			
Degree of protection	housing / terminals	IP20 / IP20			
Protection class		II			

CP-D Range Technical data

Data at $T_a = 25\text{ °C}$, $U_n = 230\text{ V AC}$ and rated values, unless otherwise indicated

Type	CP-D 24/0.42	CP-D 24/1.3	CP-D 24/2.5	CP-D 24/4.2
------	--------------	-------------	-------------	-------------

Electrical connection - Input circuit / Output circuit

Wire size	fine-strand with wire end ferrule	0.2-1.5 mm ² (24-16 AWG)	0.2-2.5 mm ² (24-14 AWG)	
	rigid	0.2-2.5 mm ² (26-12 AWG)	0.2-2.5 mm ² (24-12 AWG)	
Stripping length		4-5 mm (0.16-0.2 in)	7 mm (0.28 in)	
Tightening torque		0.6 Nm (5 lb.in)	0.7 Nm (6 lb.in)	

Environmental data

Ambient temperature range	operation	-40...+70 °C		
	rated load	-40...+60 °C	-40...+55 °C	-40...+60 °C
	storage	-40...+85 °C		
Damp heat (cyclic) (IEC/EN 60068-2-30)		4 x 24 cycles, 40 °C, 95 % RH		
Vibration (sinusoidal) (IEC/EN 60068-2-6)		50 m/s ² , 10 Hz - 2 kHz		
Shock (half-sine) (IEC/EN 60068-2-27)		40 m/s ² , 22 ms		

Isolation data

Rated insulation voltage U_i	input circuit / output circuit	3 kV AC	4 kV AC	3 kV AC
Pollution degree		2		
Overvoltage category (UL/IEC/EN 60950-1)		II		

Standards

Product standard		EN 61204		
Low Voltage Directive		2006/95/EC		
EMC Directive		2004/108/EC		
Electrical safety		UL 508, UL 60950-1, EN 60950-1		
Protective low voltage		SELV (EN 60950-1)		

Electromagnetic compatibility

Interference immunity to electrostatic discharge	IEC/EN 61000-4-2	EN 61000-6-2		
		Level 4 (4 kV / 8 kV)	Level 4 (8 kV / 15 kV)	Level 4 (4 kV / 8 kV)
radiated, radio-frequency, electromagnetic field	IEC/EN 61000-4-3	Level 3 (10 V/m)		
electrical fast transient/burst	IEC/EN 61000-4-4	Level 4 (4 kV)		
surge	IEC/EN 61000-4-5	Level 3 (2 kV L-L)		
conducted disturbances, induced by radio-frequency fields	IEC/EN 61000-4-6	Level 3 (10 V)		
Interference emission		EN 61000-6-3		
high-frequency radiated	IEC/CISPR 22, EN 55022	Class B		
high-frequency conducted	IEC/CISPR 22, EN 55022	Class B		

Approvals and marks on page 11.3.

CP-D Range

Technical data

Data at $T_a = 25\text{ °C}$, $U_{in} = 230\text{ V AC}$ and rated values, unless otherwise indicated

Type		CP- D RU
Input circuit - Supply circuit		IN 1 + + -, IN 2 + + -
Rated input voltage U_{in}		24 V DC
Input voltage range		9-35 V DC
Rated input current I_{in} per channel		5 A
Maximum input current per channel		10 A for 300 s
Transient overvoltage protection		no
Output circuit		OUT + + +, - - -
Rated output voltage U_{out}		24 V DC
Voltage drop		typ. 0.5 V
Rated output current I_{out}		10 A
Resistance to reverse feed		< 35 V
General data		
MTBF		on request
Duty time		100 %
Dimensions (W x H x D)	product dimensions	35 x 91 x 56.5 mm (1.38 x 3.58 x 2.22 in)
	packaging dimensions	134 x 94 x 48 mm (5.28 x 3.70 x 1.89 in)
Weight	net weight	0.075 kg (0.165 lb)
	gross weight	0.130 kg (0.286 lb)
Material of housing		plastic
Mounting		DIN rail, snap-on mounting without any tool
Mounting position		horizontal
Minimum distance to other units		horizontal / vertical 25 mm (0.98 in) / 25 mm (0.98 in)
Electrical connection - Input circuit / Output circuit		
Wire size	fine-strand with (out)	0.2-2.5 mm ² (24-14 AWG)
	wire end ferrule	
	rigid	
Stripping length		7.0 mm (0.28 in)
Tightening torque		0.67 Nm (6 lb.in)
Environmental data		
Ambient temperature range	operation	-40...+70 °C
	storage	-40...+85 °C
Relative humidity RH at 40 °C		20-95 %, no condensation
Vibration (IEC/EN 60068-2-6)		Mounting by rail: 10-500 Hz, 2 G, along X, Y, Z each axis, 60 min for each axis
Shock (IEC/EN 60068-2-27)		15 G, 11 ms, 3 axis, 6 faces, 3 times for each face
Standards		
Product standard		IEC/EN 61204-3
Low Voltage Directive		2006/95/EC
EMC Directive		2004/108/EC
RoHS Directive		2002/95/EC
Electromagnetic compatibility		
Interference immunity to		EN 55024
electrostatic discharge	IEC/EN 61000-4-2	Level 3, air discharge 8 kV, contact discharge 4 kV
radiated, radio-frequency, electromagnetic field	IEC/EN 61000-4-3	Level 3, 10 V/m
electrical fast transient/burst	IEC/EN 61000-4-4	Level 3, 2 kV / 5 kHz
conducted disturbances, induced by radio-frequency fields	IEC/EN 61000-4-6	Level 3, 10 V
Interference emission		EN 55022
high-frequency radiated	IEC/CISPR 22 / EN 55022	Class B
high-frequency conducted	IEC/CISPR 22 / EN 55022	Class B

CP-D Range

Technical diagrams
Approximate dimensions

Technical diagrams

Characteristic curve of output at $T_a = 25^\circ\text{C}$

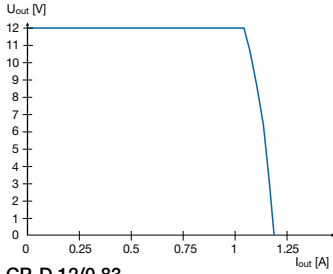

CP-D 12/0.83

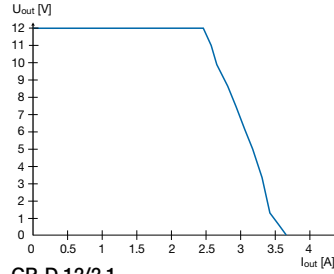

CP-D 12/2.1

Characteristic curve of Temperature at rated output voltage

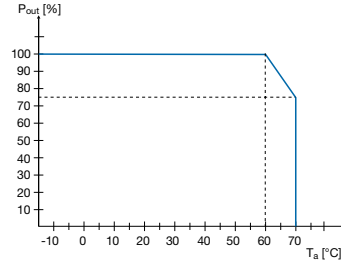

CP-D 1¹⁾

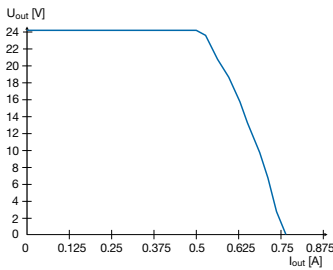

CP-D 24/0.42

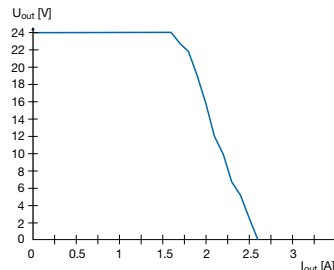

CP-D 24/1.3

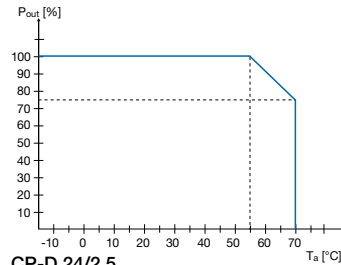

CP-D 24/2.5

11

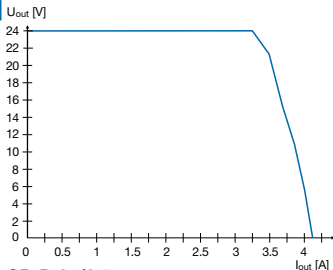

CP-D 24/2.5

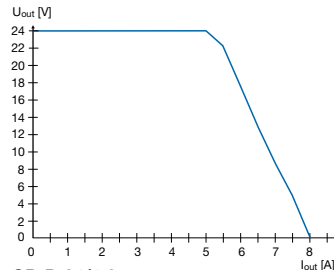

CP-D 24/4.2

¹⁾ except CP-D 24/2.5

Dimensional drawings

dimensions in mm

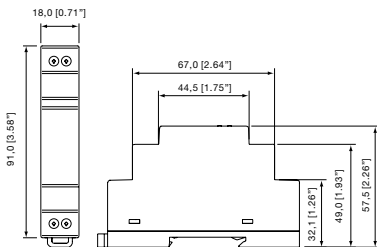

CP-D 12/0.83, CP-D 24/0.42

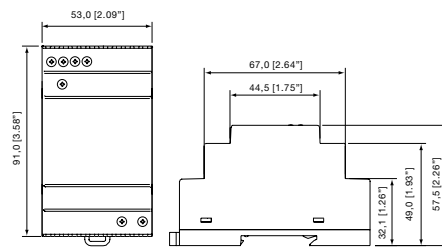

CP-D 12/2.1, CP-D 24/1.3

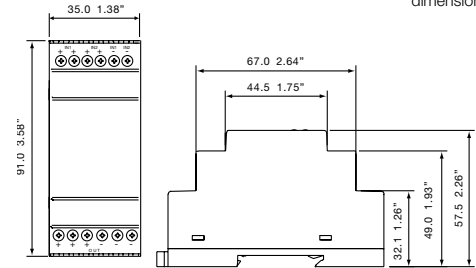

CP-D RU

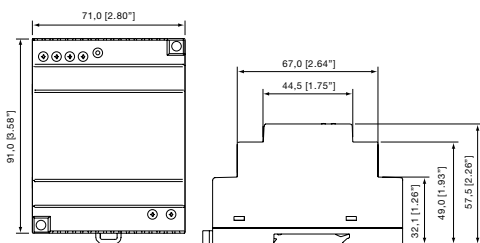

CP-D 24/2.5

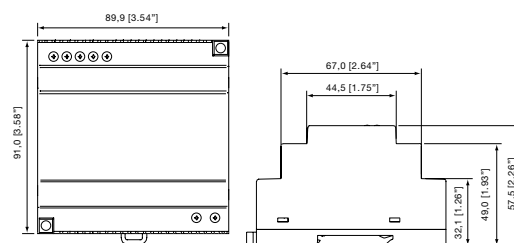

CP-D 24/4.2

Type CP-E Switch mode Power supplies



Switch mode power supplies CP-E Range

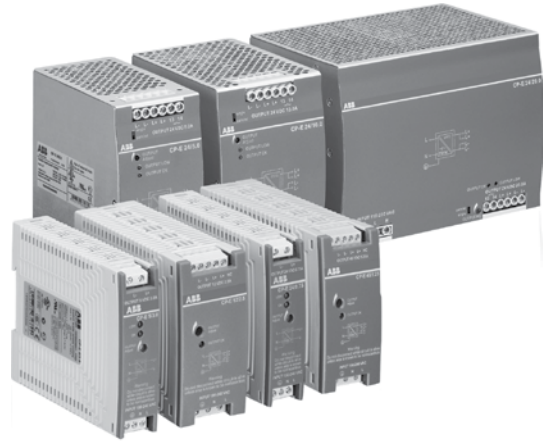

Characteristics

- Output voltages 5 V, 12 V, 24 V, 48 V DC
- Adjustable output voltages
- Output currents 0.625 A / 0.75 A / 1.25 A / 2.5 A / 3 A / 5 A / 10 A / 20 A
- Power range 15 W, 18 W, 30 W, 60 W, 120 W, 240 W, 480 W
- High efficiency of up to 90 %
- Low power dissipation and low heating
- Free convection cooling (no forced cooling with ventilators)
- Ambient temperature range during operation -40...+70 °C
- Open-circuit, overload and short-circuit stable
- Integrated input fuse
- U/I characteristic curve on devices > 18 W (fold-forward behavior at overload – no switch-off)
- Redundancy units offering true redundancy
- LED(s) for status indication
- Signalling output/contact for output voltage OK
- Transistor on 24 V devices > 18 W and < 120 W
- Relay on 24 V devices \geq 120 W
- Approvals / Marks
(depending on device, partly pending):



Benefits

Signalling output/contact

The CP-E range 24 V devices > 18 W offer an output/contact for monitoring of the output voltage and remote diagnosis.

Wide range input

Optimized for world-wide applications: The CP-E power supplies can be supplied within a wide range of AC or DC voltage.

Adjustable output voltage

The CP-E range types feature a continuously adjustable output voltage. Thus, they can be optimally adapted to the application, e.g. compensating the voltage drop caused by a long line length.

Redundancy units

For decoupling of parallelized power supply units m 40 V. Thus, true redundancy can be achieved.

CP-E Range

Description

The CP-E range offers units with output voltages from 5 V DC to 48 V DC at output currents of 0.625 A to 20 A. The high thermal efficiency of up to 90 %, corresponding to very low power and heat dissipation, allows operation without forced cooling. The functionality has been enhanced while the number of different types has been considerably reduced.

Of course all power supplies of the CP-E range are approved in accordance with all relevant international standards.



CP-E 5/3.0



CP-E 12/2.5



CP-E 24/0.75

Ordering details

Input voltage range	Rated output voltage / current	Type	Catalog number	Weight (1 pce) kg (lb)
90-264 V AC / 120-375 V DC	5 V DC / 3 A	CP-E 5/3.0	1SVR427033R3000	0.15 (0.33)
85-264 V AC / 90-375 V DC	12 V DC / 2.5 A	CP-E 12/2.5	1SVR427032R1000	0.29 (0.64)
90-132 V AC, 180-264 V AC / 210-375 V DC	12 V DC / 10 A	CP-E 12/10.0	1SVR427035R1000	1.00 (2.20)
90-264 V AC / 120-375 V DC	24 V DC / 0.75 A	CP-E 24/0.75	1SVR427030R0000	0.15 (0.33)
85-264 V AC / 90-375 V DC	24 V DC / 1.25 A	CP-E 24/1.25	1SVR427031R0000	0.29 (0.64)
85-264 V AC / 90-375 V DC	24 V DC / 2.5 A	CP-E 24/2.5	1SVR427032R0000	0.36 (0.79)
90-132 V AC, 180-264 V AC / 210-375 V DC	24 V DC / 5 A	CP-E 24/5.0	1SVR427034R0000	1.00 (2.20)
90-132 V AC, 180-264 V AC / 210-375 V DC	24 V DC / 10 A	CP-E 24/10.0	1SVR427035R0000	1.36 (3.01)
90-264 V AC / 120-375 V DC	24 V DC / 20 A	CP-E 24/20.0	1SVR427036R0000	1.90 (4.18)
85-264 V AC / 90-375 V DC	48 V DC / 0.625 A	CP-E 48/0.62	1SVR427030R2000	0.29 (0.64)
85-264 V AC / 90-375 V DC	48 V DC / 1.25 A	CP-E 48/1.25	1SVR427031R2000	0.36 (0.79)
90-132 V AC, 180-264 V AC / 210-375 V DC	48 V DC / 5 A	CP-E 48/5.0	1SVR427034R2000	1.36 (3.01)
90-264 V AC / 120-375 V DC	48 V DC / 10 A	CP-E 48/10.0	1SVR427035R2000	1.90 (4.19)

Ordering details - Redundancy units for decoupling of two CP-E power supply units

suitable for decoupling of CP-E power supply units	Description	Type	Catalog number	Weight (1 pce) kg (lb)
≤ 35 V and < 5 A	2 inputs each up to 2.5 A and 1 output up to 5 A	CP-RUD	1SVR423418R9000	0.15 (0.33)
≤ 40 V and ≥ 5 A	2 inputs each up to 20 A and 1 output up to 40 A	CP-A RU	1SVR427071R0000	0.89 (1.96)

CP-E Range

Technical data

Data at $T_a = 25^\circ\text{C}$, $U_{in} = 230\text{ V AC}$ and rated values, unless otherwise indicated

Type		CP-E 5/3.0	CP-E 12/2.5	CP-E 12/10.0
Input circuit		L, N		
Rated input voltage U_{in}		100-240 V AC		115 / 230 V AC auto select
Input voltage range		90-264 V AC / 120-375 V DC	85-264 V AC / 90-375 V DC	90-132 V AC, 180-264 V AC / 210-375 V DC
Frequency range AC		47-63 Hz		
Typical input current	at 115 V AC at 230 V AC	335 mA 210 mA	560 mA 330 mA	2.2 A 0.83 A
Typical power consumption		19.8 W	35.9 W	143 W
Inrush current limiting	at 115 V AC at 230 V AC	10 A (max. 3 ms) 18 A (max. 3 ms)	20 A (max. 3 ms) 40 A (max. 3 ms)	24 A (max. 5 ms) 48 A (max. 5 ms)
Discharge current	input / output input / PE		0.25 mA 3.5 mA	
Power failure buffering time	at 115 V AC at 230 V AC	min. 20 ms min. 75 ms	min. 20 ms min. 30 ms	min. 25 ms min. 30 ms
Internal input fuse		2 A slow-acting / 250 V AC		3.15 A slow-acting / 250 V AC
Power factor correction (PFC)		no		yes, passive, 0.7

Indication of operational states

Output voltage	green LED	OK: ┌: output voltage OK	OUTPUT OK: ┌: output voltage OK	OUTPUT OK: ┌: output voltage OK
	red LED	LOW: ┌: output voltage too low	-	OUTPUT LOW: ┌: output voltage too low

Output circuit		L+,L-	L+, L+, L-, L-	
Rated output voltage		5 V DC	12 V DC	
Tolerance of the output voltage			0...+1 %	
Adjustment range of the output voltage		4.5-5.75 V DC	12-14 V DC	11.4-14.5 V DC
Rated output power		15 W	30 W	120 W
Rated output current I_o	$T_a \leq 60^\circ\text{C}$	3.0 A	2.5 A	10 A
Derating of the output current	$60^\circ\text{C} < T_a \leq 70^\circ\text{C}$	2.5 %/°C		2.5 %/°C
Maximum deviation with	load change statical	±2 %	±0.5 %	±1 % (single mode) ±5 % (parallel mode)
	change of output voltage within the input voltage range	±1 %	±0.5 %	±0.5 %
Control time			< 2 ms	
Starting time after applying the supply voltage	at I_o with 3500 μF with 7000 μF	- max. 1.5 s	max. 1 s max. 2 s	- max. 1.5 s
Rise time	at rated load with 3500 μF with 7000 μF	- max. 500 ms	max. 150 ms max. 500 ms	- max. 500 ms
Fall time			max. 150 ms	
Residual ripple and switching peaks	BW = 20 MHz		50 mV	
Parallel connection		yes, to enable redundancy		configurable, to increase power, up to 3 devices, min. 0.1 I_o - max. 0.9 I_o
Series connection		yes, to increase voltage		yes, to increase voltage, max. 2 devices
Resistance to reverse feed		1 s - max. 7.5 V DC	1 s - max. 18 V DC	max. 18 V DC

Output circuit - No-load, overload and short-circuit behavior

Characteristic curve of output		Hiccup-mode	U/I characteristic curve	
Short-circuit protection			continuous short-circuit proof	
Short-circuit behavior		Hiccup-mode	continuation with output power limiting	
Overload protection			output power limiting	
No-load protection			continuous no-load stability	
Starting of capacitive loads		7000 μF	3500 μF	7000 μF

General data

Power dissipation		typ. 5 W	typ. 5.6 W	typ. 24 W
-------------------	--	----------	------------	-----------

CP-E Range

Technical data

Data at $T_a = 25\text{ °C}$, $U_n = 230\text{ V AC}$ and rated values, unless otherwise indicated

Type		CP-E 5/3.0	CP-E 12/2.5	CP-E 12/10.0
General data				
Power dissipation		typ. 5W	typ. 5.6 W	typ. 24W
Efficiency		typ. 75 %	typ. 84 %	typ. 84 %
Duty time		100 %		
Dimensions (W x H x D)		40.5 x 90 x 114 mm [1.59 x 3.54 x 4.49 in]	22.5 x 90 x 114 mm [0.89 x 3.54 x 4.49 in]	63.2 x 123.6 x 123.6 mm [2.49 x 4.87 x 4.87 in]
Weight		0.144 kg (0.33 lb)	0.287 kg (0.64 lb)	0.888 kg (2.20 lb)
Material of housing		Plastic		Metal
Mounting		DIN rail (IEC/EN 60715), snap-on mounting without any tool		
Mounting position		horizontal		
Minimum distance to other units	horizontal / vertical	25 mm / 25 mm (0.98 in / 0.98 in)		
Degree of protection	housing / terminals	IP20 / IP20		
Protection class		I		
Electrical connection - input circuit / output circuit				
Wire size	fine-strand with wire end ferrule			0.2-4 mm ² (24-11 AWG)
	fine-strand without wire end ferrule	0.2-2.5 mm ² (24-14 AWG)		0.2-6 mm ² (24-10 AWG)
	rigid			
Stripping length		6 mm (0.24 in)		8 mm (0.31 in)
Tightening torque	input / output	0.6 Nm (5 lb.in)		1.0 Nm (9 lb.in) / 0.62 Nm (5.5 lb.in)
Environmental data				
Ambient temperature range	operation	-20...+70 °C	-40...+70 °C	-35...+70 °C
	rated load	-20...+60 °C	-40...+60 °C	-35...+60 °C
	storage	-20...+85 °C	-40...+85 °C	-40...+85 °C
Damp heat (cyclic) (IEC/EN 60068-2-30)		95 % without condensation		
Vibration (sinusoidal) (IEC/EN 60068-2-6)		10-500 Hz, 2 G, along X, Y, Z each axis, 60 min. for each axis		
Shock (half-sine) (IEC/EN 60068-2-27)		15 G, 11 ms, 3 axes, 6 faces, 3 times for each face		
Isolation data				
Rated insulation voltage U_i	input circuit / output circuit	3 kV AC		
	input / PE	1.5 kV AC		
Pollution degree		2		
Overvoltage category (UL/IEC/EN 60950-1)		II		
Standards				
Product standard		EN 61204-3		
Low Voltage Directive		2006/95/EC		
EMC directive		2004/108/EC		
RoHS directive		2002/95/EC		
Electrical safety		EN 60950-1, UL 60950-1, UL 508	EN 60950-1, UL 60950-1, UL 508, EN 61558-1, EN 61558-2-17; EN 60204-1	
Protective low voltage		SELV (EN 60950)		
Electromagnetic compatibility				
Interference immunity to		IEC/EN 61000-6-2		
electrostatic discharge	IEC/EN 61000-4-2	Level 4 (air discharge 15 kV / contact discharge 8 kV)		
radiated, radio-frequency, electromagnetic field	IEC/EN 61000-4-3	Level 3 (10 V/m)		
electrical fast transient/burst	IEC/EN 61000-4-4	Level 4 (4 kV / 2,5 kHz)	Level 4 (4 kV / 5 kHz)	
surge	IEC/EN 61000-4-5	L-L Level 3 (2 kV) / L-PE Level 4 (4 kV)		
conducted disturbances, induced by radio-frequency fields	IEC/EN 61000-4-6	Level 3 (10 Vrms)		
power frequency magnetic fields	IEC/EN 61000-4-8	Level 4 (30 A/m)		
voltage dips, short interruptions and volt variations	IEC/EN 61000-4-11	dip: >95 % 10 ms / >30 % 500 ms interruptions: >95 % 5000 ms		
Interference emission		IEC/EN 61000-6-3		
high-frequency radiated	IEC/CISPR 22, EN 55022	Class B		
high-frequency conducted	IEC/CISPR 22, EN 55022	Class B		
limits for harmonic current emissions	IEC/EN 61000-3-2	Class D	Class A	Class D

Approvals and marks on page 11.3.

CP-E Range

Technical data

Data at $T_a = 25\text{ °C}$, $U_n = 230\text{ V AC}$ and rated values, unless otherwise indicated

Type	CP-E 24/0.75	CP-E 24/1.25	CP-E 24/2.5
Input circuit			
Rated input voltage U_n	L, N 100-240 V AC		
Input voltage range	90-264 V AC / 120-375 V DC	85-264 V AC / 90-375 V DC	
Frequency range AC	47-63 Hz		
Typical input current	at 115 V AC at 230 V AC	335 mA 210 mA	560 mA 330 mA
Typical power consumption	1060 mA 590 mA		
Inrush current limiting	at 115 V AC at 230 V AC	22.8 W 10 A (max. 3 ms) 18 A (max. 3 ms)	36.7 W 20 A (max. 3 ms) 40 A (max. 3 ms)
Discharge current	input / output input / PE	0.25 mA 3.5 mA	
Power failure buffering time	at 115 V AC at 230 V AC	min. 20 ms min. 75 ms	min. 20 ms min. 30 ms
Internal input fuse	2 A slow-acting / 250 V AC		
Power factor correction (PFC)	no		
Indication of operational states			
Output voltage	green LED	OK: ┌ └ output voltage OK	OUTPUT OK: ┌ └ output voltage OK
	red LED	LOW: ┌ └ output voltage too low	-
Output circuit			
Rated output voltage	L+,L-	L+, L+, L-, L-	
Tolerance of the output voltage	24 V DC 0 ... +1 %		
Adjustment range of the output voltage	21.6-28.8 V DC	24-28 V DC	
Rated output power	18 W	30 W	60 W
Rated output current I_o	$T_a \leq 60\text{ °C}$ 0.75 A	1.25 A	2.5 A
Derating of the output current	$60\text{ °C} < T_a \leq 70\text{ °C}$ 3 %/°C	2.5 %/°C	
Signalling output for output voltage OK	DC OK	Transistor	
Maximum deviation with	load change statical change of output voltage within the input voltage range	±2 % ±1 %	±0.5 % ±0.5 %
Control time	< 2 ms		
Starting time after applying the supply voltage	at I_o with 3500 µF with 7000 µF	- max. 1.5 s	max. 2 s - max. 1.5 s
Rise time	at rated load with 3500 µF with 7000 µF	- max. 500 ms	max. 150 ms - max. 500 ms
Fall time	max. 150 ms		
Residual ripple and switching peaks	BW = 20 MHz	50 mV	
Parallel connection	yes, to enable redundancy		
Series connection	yes, to increase voltage		
Resistance to reverse feed	1 s - max. 35 V DC		
Output circuit - No-load, overload and short-circuit behavior			
Characteristic curve of output	Hiccup-mode	U/I characteristic curve	
Short-circuit protection	continuous short-circuit proof		
Short-circuit behavior	Hiccup-mode	continuation with output power limiting	
Overload protection	output power limiting		
No-load protection	continuous no-load stability		
Starting of capacitive loads	7000 µF	3500 µF	7000 µF
General data			
Power dissipation	typ. 4.45 W	typ. 5.5 W	typ. 8.8 W
Efficiency	typ. 77 %	typ. 86 %	typ. 89 %
Duty time	100 %		
Dimensions (W x H x D)	22.5 x 90 x 114 mm [0.89 x 3.54 x 4.49 in]	40.5 x 90 x 114 mm [1.59 x 3.54 x 4.49 in]	
Weight	0.143 kg (0.33 lb)	0.270 kg (0.64 lb)	0.331 kg (0.79 lb)
Material of housing	Plastic		

CP-E Range

Technical data

Data at $T_a = 25\text{ °C}$, $U_m = 230\text{ V AC}$ and rated values, unless otherwise indicated

Type	CP-E 24/0.75	CP-E 24/1.25	CP-E 24/2.5
	22.5 x 90 x 114 mm [0.89 x 3.54 x 4.49 in]	22.5 x 90 x 114 mm [0.89 x 3.54 x 4.49 in]	
Weight	0.143 kg (0.33 lb)	0.270 kg (0.64 lb)	0.331 kg (0.79 lb)
Mounting	DIN rail (IEC/EN 60715), snap-on mounting without any tool		
Mounting position	horizontal		
Minimum distance to other units	horizontal / vertical	25 mm / 25 mm (0.98 in / 0.98 in)	
Degree of protection	housing / terminals	IP20 / IP20	
Protection class	I		

Electrical connection - input circuit / output circuit

Wire size	fine-strand with wire end ferrule fine-strand without wire end ferrule rigid	0.2-2.5 mm ² (24-14 AWG)
Stripping length		6 mm (0.24 in)
Tightening torque	input / output	0.6 Nm (5 lb.in)

Environmental data

Ambient temperature range	operation	-20...+70 °C	-40...+70 °C
	rated load	-20...+60 °C	-40...+60 °C
	storage	-20...+85 °C	-40...+85 °C
Damp heat (cyclic) (IEC/EN 60068-2-30)		95 % without condensation	
Vibration (sinusoidal) (IEC/EN 60068-2-6)		10-500 Hz, 2 G, along X, Y, Z each axis, 60 min. for each axis	
Shock (half-sine) (IEC/EN 60068-2-27)		15 G, 11 ms, 3 axes, 6 faces, 3 times for each face	

Isolation data

Rated insulation voltage U_i	input circuit / output circuit	3 kV AC
	input / PE	1.5 kV AC
Pollution degree		2
Overvoltage category (UL/IEC/EN 60950-1)		II

Standards

Product standard	EN 61204-3	
Low Voltage Directive	2006/95/EC	
EMC directive	2004/108/EC	
RoHS directive	2002/95/EC	
Electrical safety	EN 50178, EN 60950-1, UL 60950-1, UL 508	EN 60950-1, UL 60950-1, UL 508, EN 61558-1, EN 61558-2-17; EN 60204-1
Protective low voltage	SELV (EN 60950)	

Electromagnetic compatibility

Interference immunity to		IEC/EN 61000-6-2	
electrostatic discharge	IEC/EN 61000-4-2	Level 4 (air discharge 15 kV / contact discharge 8 kV)	
radiated, radio-frequency, electromagnetic field	IEC/EN 61000-4-3	Level 3 (10 V/m)	
electrical fast transient/burst	IEC/EN 61000-4-4	Level 4 (4 kV / 2.5 kHz)	Level 4 (4 kV / 5 kHz)
surge	IEC/EN 61000-4-5	L-L Level 3 (2 kV) / L-PE Level 4 (4 kV)	
conducted disturbances, induced by radio-frequency fields	IEC/EN 61000-4-6	Level 3 (10 Vrms)	
power frequency magnetic fields	IEC/EN 61000-4-8	Level 4 (30 A/m)	
voltage dips, short interruptions and voltage variations	IEC/EN 61000-4-11	dip: >95 % 10 ms / >30 % 500 ms interruptions: >95 % 5000 ms	
Interference emission		IEC/EN 61000-6-3	
high-frequency radiated	IEC/CISPR 22, EN 55022	Class B	
high-frequency conducted	IEC/CISPR 22, EN 55022	Class B	
limits for harmonic current emissions	IEC/EN 61000-3-2	Class D	Class A

Approvals and marks on page 11.3.

CP-E Range

Technical data

Data at $T_a = 25\text{ °C}$, $U_{in} = 230\text{ V AC}$ and rated values, unless otherwise indicated

Type		CP-E 24/5.0	CP-E 24/10.0	CP-E 24/20.0
Input circuit		L, N		
Rated input voltage U_{in}		115 / 230 V AC auto select		115-230 V AC
Input voltage range		90-132 V AC, 180-264 V AC / 210-375 V DC	90-132 V AC, 180-264 V AC / 210-375 V DC	90-264 V AC, 120-375 V DC
Frequency range AC		47-63 Hz		
Typical input current	at 115 V AC	2.2 A	4.0 A	4.9 A
	at 230 V AC	0.83 A	1.55 A	2.5 A
Typical power consumption		140 W	270 W	539 W
Inrush current limiting	at 115 V AC	24 A (max. 5 ms)	30 A (max. 5 ms)	25 A (max. 5 ms)
	at 230 V AC	48 A (max. 5 ms)	60 A (max. 5 ms)	50 A (max. 5 ms)
Discharge current	input / output	0.25 mA		
	input / PE	3.5 mA		
Power failure buffering time	at 115 V AC	min. 25 ms		min. 25 ms
	at 230 V AC	min. 30 ms		
Internal input fuse		3.15 A slow-acting / 250 V AC	6.3 A slow-acting / 250 V AC	10 A slow-acting / 250 V AC
Power factor correction (PFC)		yes, passive, 0.7		yes, active 115 V AC: 0.99 230 V AC: 0.97

Indication of operational states

Output voltage	green LED	OUTPUT OK:  : output voltage OK
	red LED	OUTPUT LOW:  : output voltage too low

Output circuit		L+, L+, L-, L-		
Rated output voltage		24 V DC		
Tolerance of the output voltage		0...+1 %		
Adjustment range of the output voltage		22.5-28.5 V DC		
Rated output power		120 W	240 W	480 W
Rated output current I_r	$T_a \leq 60\text{ °C}$	5 A	10 A	-
	$T_a \leq 55\text{ °C}$	-	-	20 A
Derating of the output current	$60\text{ °C} < T_a \leq 70\text{ °C}$	2.5 %/°C		-
	$55\text{ °C} < T_a \leq 70\text{ °C}$	-	-	2.5 %/°C
Signalling contact for output voltage OK	13-14	solid-state (max. 60 V DC, 0.3 A)		
Minimum fuse rating to achieve short-circuit protection	13-14	$\geq 60\text{ V DC}$, $\leq 0.3\text{ A}$ fast-acting		
Maximum deviation with load change statical		$\pm 1\%$ (single mode) $\pm 5\%$ (parallel mode)		
	change of output voltage within the input voltage range	$\pm 0.5\%$		
Control time		$< 2\text{ ms}$		
Starting time after applying the supply voltage	at I_r	max. 1 s		
	with 3500 μF	max. 1.5 s	-	-
	with 7000 μF	-	max. 1.5 s	
Rise time	at rated load	max. 150 ms		
	with 3500 μF	max. 500 ms	-	-
	with 7000 μF	-	max. 500 ms	
Fall time		max. 150 ms		
Residual ripple and switching peaks	BW = 20 MHz	50 mV	100 mV	
Parallel connection		configurable, to increase power, up to 3 devices, min. 0.1 I_r - max. 0.9 I_r		
Series connection		yes, to increase voltage, max. 2 devices		
Resistance to reverse feed		max. 35 V DC		

Output circuit - No-load, overload and short-circuit behavior

Characteristic curve of output		U/I characteristic curve	
Short-circuit protection		continuous short-circuit proof	
Short-circuit behavior		continuation with output power limiting	
Overload protection		output power limiting	
No-load protection		continuous no-load stability	
Starting of capacitive loads		3500 μF	7000 μF

CP-E Range

Technical data

Data at $T_a = 25\text{ °C}$, $U_n = 230\text{ V AC}$ and rated values, unless otherwise indicated

Type		CP-E 24/5.0	CP-E 24/10.0	CP-E 24/20.0
General data				
Power dissipation		typ. 20 W	typ. 35 W	typ. 63 W
Efficiency		typ. 86 %	typ. 89 %	typ. 89 %
Duty time		100 %		
Dimensions (W x H x D)		63.2 x 123.6 x 123.6 mm [2.49 x 4.87 x 4.87 in]	83 x 123.6 x 123.6 mm [3.27 x 4.87 x 4.87 in]	175 x 123.6 x 123.6 mm [6.89 x 4.87 x 4.87 in]
Weight		0.882 kg (2.20 lb)	1.334 kg (3.01 lb)	1.850 kg (4.19 lb)
Material of housing		Metal		
Mounting		DIN rail (IEC/EN 60715), snap-on mounting without any tool		
Mounting position		horizontal		
Minimum distance to other units	horizontal / vertical	25 mm / 25 mm (0.98 in / 0.98 in)		
Degree of protection	housing / terminals	IP20 / IP20		
Protection class		I		
Electrical connection - input circuit / output circuit				
Wire size	fine-strand with wire end ferrule	0.2-4 mm ² (24-11 AWG)		
	fine-strand without wire end ferrule	0.2-6 mm ² (24-10 AWG)		
	rigid			
Stripping length		8 mm (0.31 in)		
Tightening torque	input / output	1.0 Nm (9 lb.in) / 0.62 Nm (5.5 lb.in)		
Environmental data				
Ambient temperature range	operation	-35...+70 °C	-40...+70 °C	
	rated load	-35...+60 °C	-40...+60 °C	-40...+55 °C
	storage	-40...+85 °C	-40...+85 °C	
Damp heat (cyclic) (IEC/EN 60068-2-30)		95 % without condensation		
Vibration (sinusoidal) (IEC/EN 60068-2-6)		10-500 Hz, 2 G, along X, Y, Z each axis, 60 min. for each axis		
Shock (half-sine) (IEC/EN 60068-2-27)		15 G, 11 ms, 3 axes, 6 faces, 3 times for each face		
Isolation data				
Rated insulation voltage U_i	input circuit / output circuit	3 kV AC		
	input / PE	1.5 kV AC		
Pollution degree		2		
Overvoltage category (UL/IEC/EN 60950-1)		II		
Standards				
Product standard		EN 61204-3		
Low Voltage Directive		2006/95/EC		
EMC directive		2004/108/EC		
RoHS directive		2002/95/EC		
Electrical safety		EN 60950-1, UL 60950-1, UL 508, EN 61558-1, EN 61558-2-17; EN 60204-1		
Protective low voltage		SELV (EN 60950)		
Electromagnetic compatibility				
Interference immunity to		IEC/EN 61000-6-2		
electrostatic discharge	IEC/EN 61000-4-2	Level 4 (air discharge 15 kV / contact discharge 8 kV)		
radiated, radio-frequency, electromagnetic field	IEC/EN 61000-4-3	Level 3 (10 V/m)		
electrical fast transient/burst	IEC/EN 61000-4-4	Level 4 (4 kV / 5 kHz)	Level 4 (4 kV / 2.5 kHz)	Level 4 (4 kV / 5 kHz)
surge	IEC/EN 61000-4-5	L-L Level 3 (2 kV) / L-PE Level 4 (4 kV)		
conducted disturbances, induced by radio-frequency fields	IEC/EN 61000-4-6	Level 3 (10 Vrms)		
power frequency magnetic fields	IEC/EN 61000-4-6	Level 4 (30 A/m)		
voltage dips, short interruptions and voltage variations	IEC/EN 61000-4-6	dip: >95 % 10 ms / >30 % 500 ms interruptions: >95 % 5000 ms		
Interference emission		IEC/EN 61000-6-3		
high-frequency radiated	IEC/CISPR 22, EN 55022	Class B		
high-frequency conducted	IEC/CISPR 22, EN 55022	Class B		
limits for harmonic current emissions		Class D		

Approvals and marks on page 11.3.

CP-E Range

Technical data

Data at $T_a = 25\text{ }^\circ\text{C}$, $U_{in} = 230\text{ V AC}$ and rated values, unless otherwise indicated

Type		CP-E 48/0.62	CP-E 48/1.25	CP-E 48/5.0	CP-E 48/10.0
Input circuit		L, N			
Rated input voltage U_{in}		100-240 V AC		115 / 230 V AC auto select	115-230 V AC
Input voltage range		85-264 V AC / 90-375 V DC		90-132 V AC, 180-264 V AC / 210-375 V DC	90-264 V AC, 120-375 V DC
Frequency range AC		47-63 Hz			
Typical input current	at 115 V AC	560 mA	1060 mA	4.0 A	4.9 A
	at 230 V AC	330 mA	590 mA	1.55 A	2.5 A
Typical power consumption		35.7 W		267 W	528 W
Inrush current limiting	at 115 V AC	20 A (max. 3 ms)	20 A (max. 3 ms)	30 A (max. 5 ms)	25 A (max. 5 ms)
	at 230 V AC	40 A (max. 3 ms)	40 A (max. 3 ms)	60 A (max. 5 ms)	50 A (max. 5 ms)
Discharge current	input / output	0.25 mA			
	input / PE	3.5 mA			
Power failure buffering time	at 115 V AC	min. 20 ms		min. 25 ms	min. 25 ms
	at 230 V AC	min. 30 ms			
Internal input fuse		2 A slow-acting / 250 V AC		6.3 A slow-acting / 250 V AC	10 A slow-acting / 250 V AC
Power factor correction (PFC)		no		yes, passive, 0.7	yes, active 115 V AC: 0.99 230 V AC: 0.97
Indication of operational states					
Output voltage	green LED	OUTPUT OK: ┌───┐ └───┘ output voltage OK			
	red LED	-	-	OUTPUT LOW: ┌───┐ └───┘ output voltage too low	
Output circuit		L+, L+, L-, L-			
Rated output voltage		48 V DC			
Tolerance of the output voltage		0...+1 %			
Adjustment range of the output voltage		48-55 V DC		47-56 V DC	
Rated output power		30 W	60 W	240 W	480 W
Rated output current I_o	$T_a \leq 60\text{ }^\circ\text{C}$	0.625 A	1.25 A	5 A	-
	$T_a \leq 55\text{ }^\circ\text{C}$	-	-	-	10 A
Derating of the output current	$60\text{ }^\circ\text{C} < T_a \leq 70\text{ }^\circ\text{C}$	2.5 %/°C			
	$55\text{ }^\circ\text{C} < T_a \leq 70\text{ }^\circ\text{C}$	-	-	-	2.5 %/°C
Signalling output for output voltage OK	DC OK	-	-	-	-
Maximum deviation with	load change statical	±0.5 %		±1 % (single mode) ±5 % (parallel mode)	
	change of output voltage within the input voltage range	±0.5 %		±0.5 %	
Control time		< 2 ms			
Starting time after applying the supply voltage	at I_o	max. 1 s			
	with 3500 μF	max. 2 s	-	-	-
	with 7000 μF	-	max. 1.5 s	-	max. 1.5 s
Rise time	at rated load	max. 150 ms			
	with 3500 μF	max. 500 ms	-	-	-
	with 7000 μF	-	max. 500 ms	-	max. 500 ms
Fall time		max. 150 ms			
Residual ripple and switching peaks	BW = 20 MHz	50 mV		100 mV	
Parallel connection		yes, to enable redundancy		configurable, to increase power, up to 3 devices, min. 0.1 I - max. 0.9 I	
Series connection		yes, to increase voltage		yes, to increase voltage, max. 2 devices	
Resistance to reverse feed		1 s - max. 63 V DC			
Output circuit - No-load, overload and short-circuit behavior					
Characteristic curve of output		U/I characteristic curve			
Short-circuit protection		continuous short-circuit proof			
Short-circuit behavior		continuation with output power limiting			
Overload protection		output power limiting			
No-load protection		continuous no-load stability			
Starting of capacitive loads		3500 μF		7000 μF	
General data					
Power dissipation		typ. 4.9 W	typ. 7.8 W	typ. 32 W	typ. 60 W

CP-E Range Technical data

Data at $T_a = 25\text{ °C}$, $U_n = 230\text{ V AC}$ and rated values, unless otherwise indicated

Type	CP-E 48/0.62	CP-E 48/1.25	CP-E 48/5.0	CP-E 48/10.0
Efficiency	typ. 86 %	typ. 89 %	typ. 90 %	typ. 89 %
Duty time	100 %			
Dimensions (W x H x D)	40.5 x 90 x 114 mm [1.59 x 3.54 x 4.49 in]		83 x 123.6 x 123.6 mm [3.27 x 4.87 x 4.87 in]	175 x 123.6 x 123.6 mm [6.89 x 4.87 x 4.87 in]
Weight	0.264 kg (0.58 lb)	0.316 kg (0.70 lb)	1.322 kg (2.91 lb)	1.839 kg (4.05 lb)
Material of housing	Plastic		Metal	
Mounting	DIN rail (IEC/EN 60715), snap-on mounting without any tool			
Mounting position	horizontal			
Minimum distance to other units	horizontal / vertical 25 mm / 25 mm (0.98 in / 0.98 in)			
Degree of protection	housing / terminals IP/20 / IP20			
Protection class				

Electrical connection - input circuit / output circuit

Wire size	fine-strand with wire end ferrule	0.2-2.5 mm ² (24-14 AWG)	0.2-4 mm ² (24-11 AWG)
	fine-strand without wire end ferrule		0.2-6 mm ² (24-10 AWG)
	rigid		
Stripping length		6 mm (0.24 in)	8 mm (0.31 in)
Tightening torque	input / output	0.6 Nm (5 lb.in)	1.0 Nm (9 lb.in) / 0.62 Nm (5.5 lb.in)

Environmental data

Ambient temperature range	operation	-40...+70 °C	
	rated load	-40...+60 °C	-40...+55 °C
	storage	-40...+85 °C	
Damp heat (cyclic) (IEC/EN 60068-2-30)		95 % without condensation	
Vibration (sinusoidal) (IEC/EN 60068-2-6)		10-500 Hz, 2 G, along X, Y, Z each axis, 60 min. for each axis	
Shock (half-sine) (IEC/EN 60068-2-27)		15 G, 11 ms, 3 axes, 6 faces, 3 times for each face	

Isolation data

Rated insulation voltage U_i	input circuit / output circuit	3 kV AC
	input / PE	1.5 kV AC
Pollution degree		2
Overtoltage category (UL/IEC/EN 60950-1)		II

Standards

Product standard	EN 61204-3
Low Voltage Directive	2006/95/EC
EMC directive	2004/108/EC
RoHS directive	2002/95/EC
Electrical safety	EN 60950-1, UL 60950-1, UL 508, EN 61558-1, EN 61558-2-17; EN 60204-1
Protective low voltage	SELV (EN 60950)

Electromagnetic compatibility

Interference immunity to		IEC/EN 61000-6-2
electrostatic discharge	IEC/EN 61000-4-2	Level 4 (air discharge 15 kV / contact discharge 8 kV)
radiated, radio-frequency, electromagnetic field	IEC/EN 61000-4-3	Level 3 (10 V/m)
electrical fast transient/burst	IEC/EN 61000-4-4	Level 4 (4 kV / 5 kHz)
surge	IEC/EN 61000-4-5	Level 4 (4 kV / 2.5 kHz)
conducted disturbances, induced by radio-frequency fields	IEC/EN 61000-4-6	L-L Level 3 (2 kV) / L-PE Level 4 (4 kV)
power frequency magnetic fields	IEC/EN 61000-4-6	Level 3 (10 V/m)
voltage dips, short interruptions and volt variations	IEC/EN 61000-4-6	Level 4 (30 A/m)
Interference emission		dip: >95 % 10 ms / >30 % 500 ms interruptions: >95 % 5000 ms
high-frequency radiated	IEC/CISPR 22, EN 55022	IEC/EN 61000-6-3 Class B
high-frequency conducted	IEC/CISPR 22, EN 55022	Class B
limits for harmonic current emissions		Class A
		Class D

Approvals and marks on page 11.3.

CP-E Range

Technical data

Data at T_a = 25 °C, unless otherwise indicated

Type	CP-RUD	CP- A RU
Input circuit - Supply circuit	A: U1+/-U ; B: U2+/-U	(+/-, +/-)
Rated input voltage U _{in}	24 V DC	24 V DC
Input voltage range	5-35 V DC	10-40 V DC
Rated input current I _{in} per channel	0.5-2.5 A	1-20 A
Maximum input current per channel	10 A for 300 s	30 A for 300 s
Transient overvoltage protection	no	yes
Output circuit	L+, L+, L+, L-, L-, L-	(+/-/-)
Rated output voltage U _{out}	24 V DC	24 V DC
Voltage drop	typ. 0.6 V, max. 0.7 V	typ. 0.6 V, max. 0.9 V
Rated output current I _{out}	0.5-5 A	1-40 A
Peak output current	20 A for 150 s	60 A for 300 s
Resistance to reverse feed	< 35 V	< 40 V
General data		
Dimensions (W x H x D)	22.5 x 78 x 100 mm (0.89 x 3.07 x 4.02 in)	56.5 (60 ¹⁾) x 130 x 135.5 mm (2.22 (2.36 ¹⁾) x 5.12 x 5.39 in)
Weight	0.135 kg (0.30 lb)	0.89 kg (1.96 lb)
Minimum distance to other units	horizontal / vertical	horizontal / vertical
Degree of protection	housing / terminals	IP20 / IP20
Material of housing	housing shell / cover	plastic / plastic
Protection class		aluminium / zinc-coated sheet steel III ²⁾
Mounting		DIN rail (IEC/EN 60715)
Mounting position		horizontal
Electrical connection - Input circuit / Output circuit		
Wire size	fine-strand with wire end ferrule	2 x 0.75-2.5 mm ² (2 x 18-14 AWG)
	fine-strand without wire end ferrule	2.5-10 mm ² (14-8 AWG)
	rigid	0.5-10 mm ² (20-8 AWG)
Stripping length		2 x 0.5-4 mm ² (2 x 20-12 AWG)
Tightening torque		7 mm (0.28 in)
		0.6-0.8 Nm
		1.2-1.5 Nm
Environmental data		
Ambient temperature range	operation	-20...+60 °C
	rated load	-20...+60 °C
	storage	-25...+70 °C
Damp heat (IEC/EN 60068-2-3)		-25...+60 °C (without derating)
Climatic category (IEC/EN 60721)		40...+85 °C
Vibration (IEC/EN 60068-2-6)		93 % at 40 °C, no condensation
Shock (IEC/EN 60068-2-27)		3K3
Isolation data		
Insulation voltage	between input / output / housing	500 V AC (routine test)
Pollution degree (EN 50178)		2
Standards		
Product standard		IEC/EN 61204
Low Voltage Directive		2006/95/EG
EMC Directive		2004/108/EG
Electrical safety	EN 50178	EN 50178, EN 60950, UL 60950, UL 508
Electromagnetic compatibility		
Interference immunity to		IEC/EN 61000-6-2
electrostatic discharge	IEC/EN 61000-4-2	Level 3 (air discharge ±8 kV, contact discharge ±6 kV)
radiated, radio-frequency, electromagnetic field	IEC/EN 61000-4-3	Level 3 (10 V/m)
electrical fast transient/burst	IEC/EN 61000-4-4	Level 3 (±2 kV)
surge	IEC/EN 61000-4-5	Level 1 (w0.5 kV)
conducted disturbances, induced by radio-frequency fields	IEC/EN 61000-4-6	Level 3 (10 V)
Interference emission		IEC/EN 61000-6-3
high-frequency radiated	IEC/CISPR 22 / EN 55022	Class B
high-frequency conducted	IEC/CISPR 22 / EN 55022	Class B

1) incl. lateral screw

2) This device is designed for connection to a safety extra-low voltage source. If no safety extra-low voltage is used at the input side, the lateral screw can be used for grounding of the housing (protection class I).

CP-E Range

Technical diagrams

Wiring schematics

Technical diagrams

Output curve at $T_a = 25^\circ\text{C}$

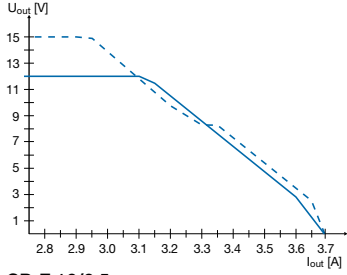

CP-E 12/2.5

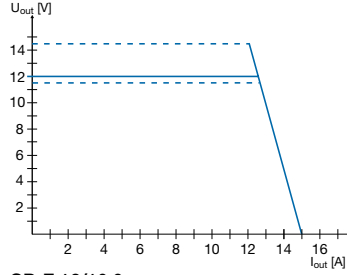

CP-E 12/10.0

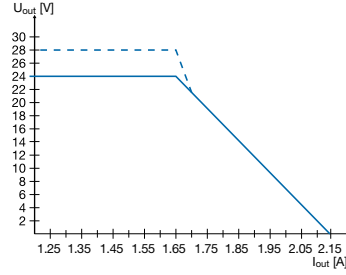

CP-E 24/1.25

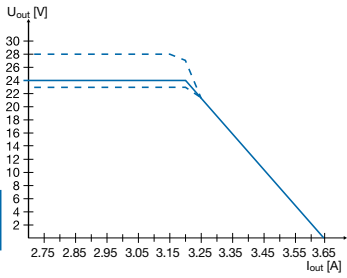

CP-E 24/2.5

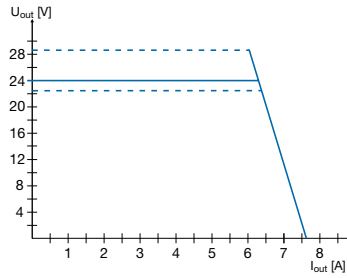

CP-E 24/5.0

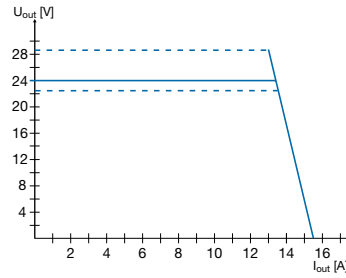

CP-E 24/10.0

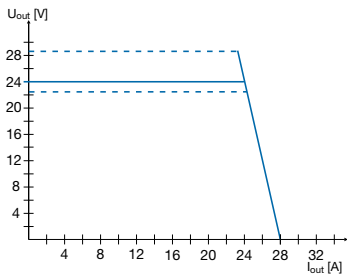

CP-E 24/20.0

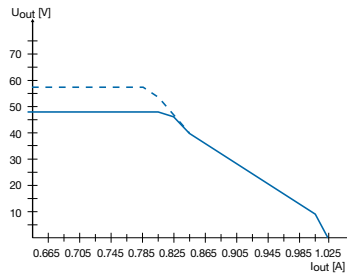

CP-E 48/0.62

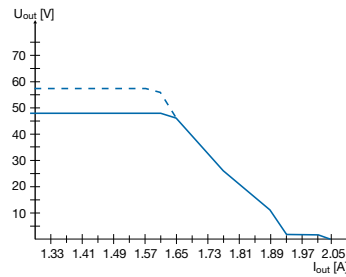

CP-E 48/1.25

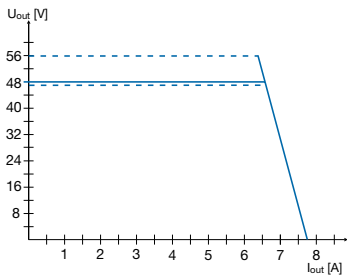

CP-E 48/5.0

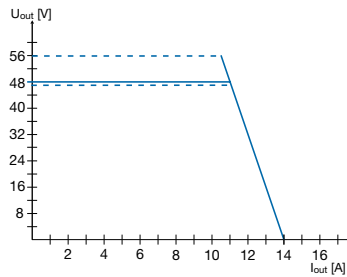

CP-E 48/10.0

Wiring schematics

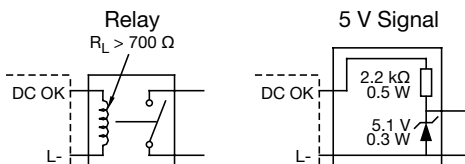

CP-E 24/1.25, CP-E 24/2.5

CP-E Range

Technical diagrams

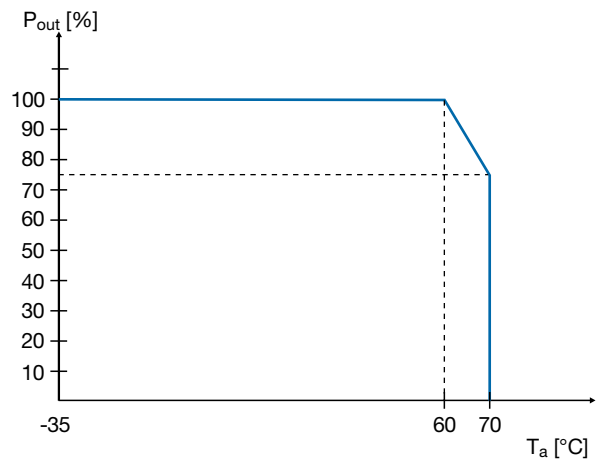

CP-E 12/10.0, CP-E 24/5.0

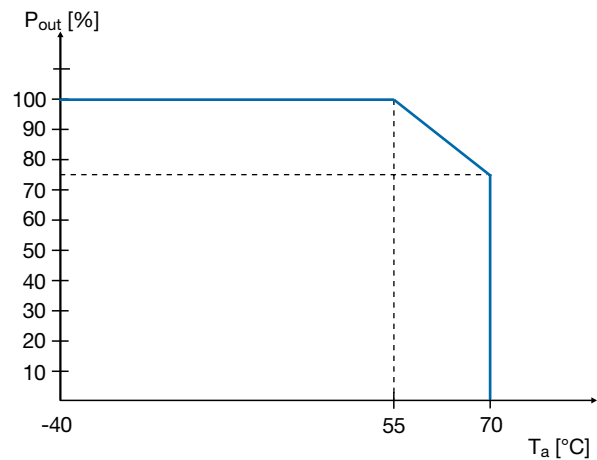

CP-E 24/20.0, CP-E 48/10.0

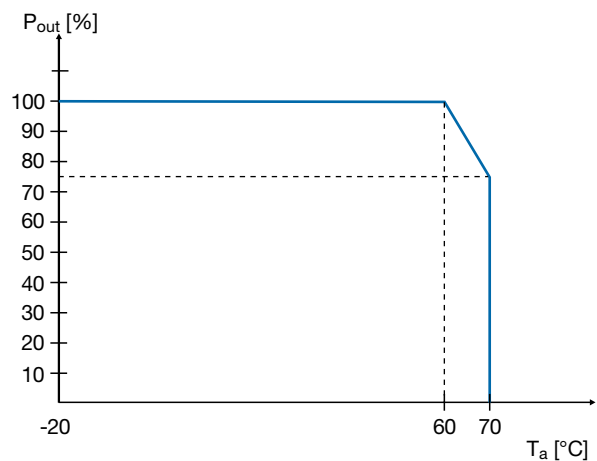

CP-E 5/3.0, CP-E 24/0.75

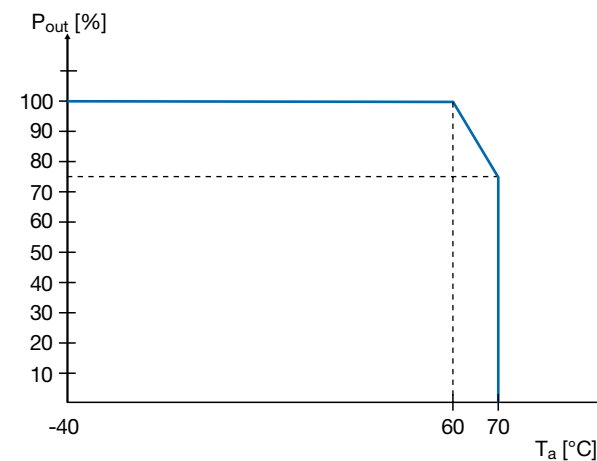

CP-E 12/2.5, CP-E 24/1.25, CP-E 48/0.62,
CP-E 24/2.5, CP-E 48/1.25, CP-E 24/10.0, CP-E 48/5.0

CP-E Range

Approximate dimensions

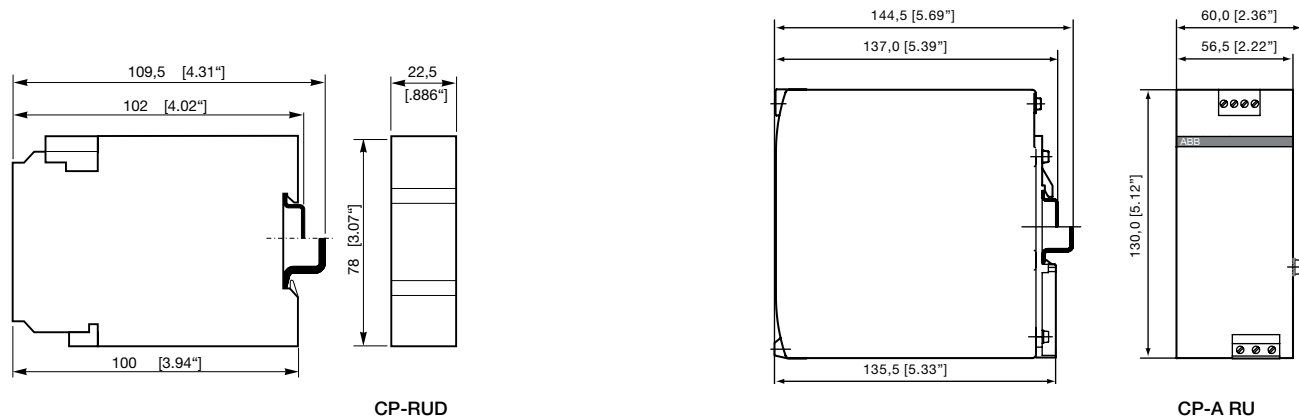
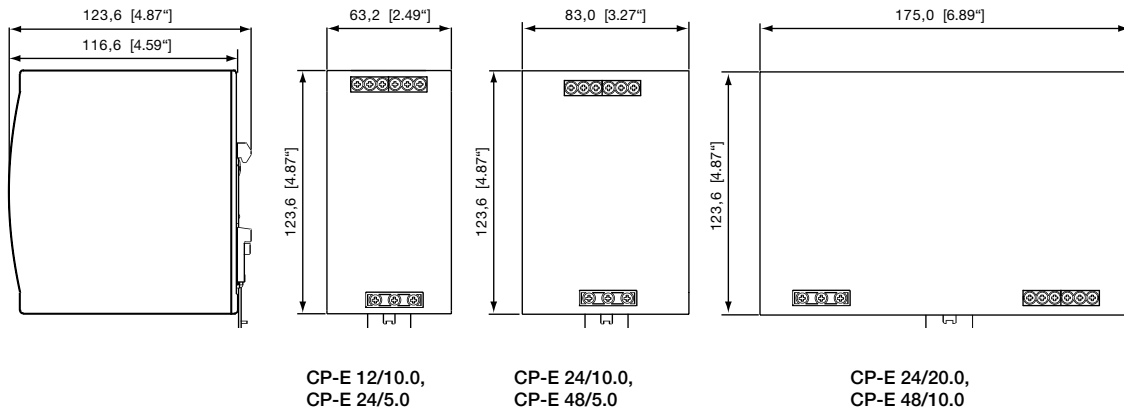
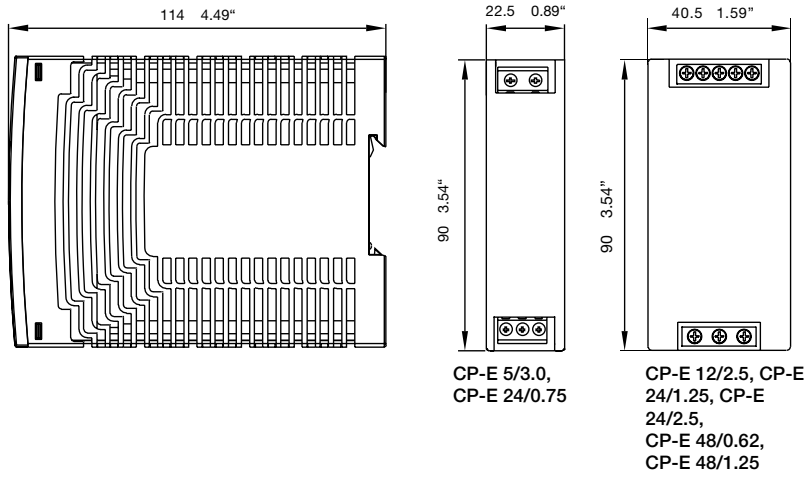

Type CP-T Switch mode Power supplies



Switch mode power supplies CP-T Range



Characteristics

- Rated output voltages 24 V, 48 V DC
- Output voltage adjustable via front-face rotary potentiometer "OUTPUT Adjust"
- Rated output currents 5 A, 10 A, 20 A, 40 A
- Rated output powers 120 W, 240 W, 480 W, 960 W
- Three-phase or two-phase operation (see derating note)
- Supply range 3 x 400 – 500 V AC (3 x 340 – 575 V AC, 480 – 820 V DC)
- Typical efficiency of 93 %
- Low power dissipation and low heating
- Free convection cooling (no forced cooling with ventilators)
- Ambient temperature range during operation -40...+70 °C 1)
- Open-circuit, overload and short-circuit stable
- Integrated input fuse
- Redundancy unit CP-A RU offering true redundancy, available as accessory
- LEDs for status indication
- Signalling contact "13-14" (solid state) for output voltage OK
- Approvals / marks (depending on device, partly pending):



Benefits

Signalling output

The devices of the CP-T series offer a solid state output for function monitoring and remote diagnostics.

Wide input range

Wide range input optimized for world-wide applications: The CP-T power supplies can be used in 340 - 575 V AC or 480 - 820 V DC supply systems.

Adjustable output voltage

The CP-T range feature a continuously adjustable output voltage. Thus, they can be optimally adapted to the application, e.g. compensating the voltage drop caused by a long line length.

¹⁾ 480 W variants: -30...+70°C

CP-T Range

Ordering details

Description

The CP-T range of three-phase power supply units is the youngest member of ABB's power supply family. In terms of design and functionality, the new range perfectly supplements

the existing products and extends the range appropriately. The devices can be supplied with a three-phase voltage as well as with two-phase mains. Here, ABB offers power supply units with 24 V DC and 48 V DC outputs with 5 A, 10 A, 20 A and 40 A and efficiency of up to 92 %. As in the case of all products, they are designed for an ambient temperature of up to 70 °C.

All products can be supplied within a AC supply voltage range between 340 to 575 V AC and an DC supply voltage range between 480 to 820VDC.



CP-T 24/5.0



CP-T 24/10.0, CP-T 48/5.0



CP-T 24/20.0, CP-T 48/10.0

Ordering details

Input voltage range	Rated output voltage / current	Type	Catalog number	Weight (1 pce) kg (lb)
340-575 V AC / 480-820 V DC	24 V DC / 5 A	CP-T 24/5.0	1SVR427054R0000	0.80 (1.77)
340-575 V AC / 480-820 V DC	24 V DC / 10 A	CP-T 24/10.0	1SVR427055R0000	1.05 (2.31)
340-575 V AC / 480-820 V DC	24 V DC / 20 A	CP-T 24/20.0	1SVR427056R0000	1.75 (3.86)
340-575 V AC / 480-820 V DC	24 V DC / 40 A	CP-T 24/40.0	1SVR427057R0000	3.20 (7.05)
340-575 V AC / 480-820 V DC	48 V DC / 5 A	CP-T 48/5.0	1SVR427054R2000	1.05 (2.31)
340-575 V AC / 480-820 V DC	48 V DC / 10 A	CP-T 48/10.0	1SVR427055R2000	1.75 (3.86)
340-575 V AC / 480-820 V DC	48 V DC / 20 A	CP-T 48/20.0	1SVR427056R2000	3.40 (7.50)

Ordering details - Redundancy units for decoupling of two CP-T power supply units

suitable for decoupling of two CP-24 V DC power supply units	Description	Type	Catalog number	Weight (1 pce) kg (lb)
≤ 40 V and < 5 A	2 inputs each up to 20 A and 1 output up to 40 A	CP-A RU	1SVR427071R0000	0.89 (1.96)

CP-T Range

Technical data

Data at $T_a = 25\text{ °C}$, $U_{in} = 3 \times 400\text{ V AC}$ and rated values, unless otherwise indicated

Type	CP-T 24/5.0	CP-T 24/10.0	CP-T 24/20.0	CP-T 24/40.0
Input circuit	L1, L2, L3			
Rated input voltage U_n	3 x 400-500 V AC			
Input voltage range	340-575 V AC 480-820 V DC			
Frequency range AC	47-63 Hz			
Typical input current	0.36 A	0.65 A	1.1 A	1.72 A
Typical power consumption	135 W	270 W	538 W	1058 W
Inrush current limiting	10 A	20 A		30 A
Power failure buffering time	min. 20 ms			min. 15 ms
Internal input fuse	per phase 2 A / 600 V AC		T3.15 A / 500 V AC	
Recommended backup fuse	3 pole miniature circuit breaker ABB Type S203			
Power factor correction (PFC)	Yes, passive			
Discharge current	towards PE input / output		< 3.5 mA < 0.25 mA	
Indication of operational states				
Output voltage	OUTPUT OK: green LED OUTPUT LOW: red LED		output voltage OK output voltage too low	
Output circuit	L+, L+, L-, L-			
Rated output voltage	24 V DC			
Tolerance of the output voltage	0...+1 %			
Adjustment range of the output voltage	22.5-28.5 V DC			
Rated output power	120 W	240 W	480 W	960 W
Rated output current I	$T_a \leq 60\text{ °C}$ 5 A	10 A	20 A	40 A
Derating of the output current	$60\text{ °C} < T_a \leq 70\text{ °C}$		2.5 %/°C	
Signalling contact for output voltage OK	13-14 Threshold Isolation voltage	solid state (max. 60 V DC, 0.3 A) 17.6-19.4 V 500 V DC		
Minimum fuse rating to achieve short-circuit protection	13-14 $\geq 60\text{ V DC}, \leq 0.3\text{ A fast-acting}$			
Maximum deviation with	load change statical	$\pm 1\%$	$\pm 1\%$ (single mode) $\pm 5\%$ (parallel mode)	
	change of output voltage within the input voltage range	-	$\pm 0.5\%$	
Control time	at nominal load			
Starting time after applying the supply voltage	at I_r		< 2 ms max. 1 s	
Rise time	with 3500 μF at nominal load with 3500 μF		max. 1.5 s max. 150 ms max. 500 ms max. 150 ms	
Fall time	max. 150 ms			
Residual ripple and switching peaks	BW = 20 MHz		100 mV	80 mV
Parallel connection	not supported	configurable, to increase power, up to 2 devices, reduction: (number of devices x I) x 0.9		to increase power, up to 2 devices, reduction: (number of devices x I) x 0.9, use active current balancing
Series connection	not supported			
Resistance to reverse feed	yes, to increase voltage, max. 2 devices approx. 35 V			
Output circuit - No-load, overload and short-circuit behavior				
Characteristic curve of output	combined U/I characteristic curve and hiccup mode		U/I- or Hiccup-mode adjustable	hiccup / fold back behavior
Short-circuit protection	continuous short-circuit proof			
Short-circuit behavior	current limiting			
Overload protection	hiccup mode			
No-load protection	continuous no-load stability			
Overtemperature protection	yes, automatic recovery after temperature went down			
Starting of capacitive loads	3500 μF	7000 μF	7000 μF	7000 μF
General data				
Efficiency	typ. 89 %		typ. 90 %	
Duty time	100%			
Dimensions (W x H x D)	74.3 x 124 x 118.8 mm [2.92 x 4.88 x 4.68 in]	89 x 124 x 118.8 mm [3.5 x 4.88 x 4.68 in]	150 x 124 x 118.8 mm [5.91 x 4.88 x 4.68 in]	275.8 x 124 x 118.8 mm [10.86 x 4.88 x 4.68 in]
Weight	0.78 kg (1.72 lb)	1.045 kg (2.30 lb)	1.657 kg (3.653 lb)	3.275 kg (7.220 lb)
Material of housing	Metal			
Mounting	DIN rail (IEC EN 60715), snap-on mounting without any tool			
Mounting position	horizontal			
Minimum distance to other units	horizontal / vertical		25 mm / 25 mm (0.98 in / 0.98 in)	

CP-T Range

Technical data

Data at $T_a = 25\text{ °C}$, $U_n = 3 \times 400\text{ V AC}$ and rated values, unless otherwise indicated

Type	CP-T 24/5.0	CP-T 24/10.0	CP-T 24/20.0	CP-T 24/40.0
Degree of protection	housing / terminals			
Protection class	IP20 / IP20			
Electrical connection - input circuit / output circuit				
Wire size				Input circuit L1, L2, L3: 0.2-4 mm ² (24-11 AWG) Output circuit L+, L+, L-, L-: 0.5-10 mm ² (20-8 AWG) Signalling circuit: 0.2-4 mm ² (24-11 AWG)
fine-strand with wire end ferrule		0.2-4 mm ² (24-11 AWG)		
fine-strand without wire end ferrule		0.2-6 mm ² (24-10 AWG)		Input circuit L1, L2, L3: 0.2-6 mm ² (24-11 AWG) Output circuit L+, L+, L-, L-: 0.5-16 mm ² (20-6 AWG) Signalling circuit: 0.2-6 mm ² (24-10 AWG)
rigid		0.2-6 mm ² (24-10 AWG)		Input circuit L1, L2, L3: 0.2-6 mm ² (24-11 AWG) Output circuit L+, L+, L-, L-: 0.5-16 mm ² (20-6 AWG) Signalling circuit: 0.2-6 mm ² (24-10 AWG)
Stripping length	8 mm (0.31 in)			
Tightening torque	input / output	1 Nm / 0.6 Nm		1 Nm / 1.8 Nm

Environmental data

Ambient temperature range	operation	-40...+70 °C	-30...+70 °C	-40...+70 °C
	rated load	-40...+70 °C	-30...+70 °C	-40...+70 °C
	storage	-40...+85 °C		
Damp heat (cyclic) (IEC/EN 60068-2-30)	95 % without condensation			
Vibration (sinusoidal) (IEC/EN 60068-2-6)	10-500 Hz, 2G, each along X, Y, Z axes 6 min / cycle			
Shock (half-sine) (IEC/EN 60068-2-27)	Half sine wave, 15G, 11 ms, 3 axes, 6 Faces, 3 times for each face			

Isolation data

Rated insulation voltage U_i	input circuit / output circuit	3 kV AC
	input / PE	1.5 kV AC
Pollution degree		2

Standards

Product standard	EN 61204-3
Low Voltage Directive	2006/95/EN
EMC directive	2004/108/EN
RoHS directive	2002/95/EN
Electrical safety	EN 60950-1, UL 60950-1, UL 508, EN 61558-1, EN 61558-2-17; EN 60204-1
Protective low voltage	SELV

Electromagnetic compatibility

Interference immunity to electrostatic discharge	IEC/EN 61000-4-2	IEC/EN 61000-6-2
radiated, radio-frequency, electromagnetic field	IEC/EN 61000-4-3	Level 4 (air discharge 15 kV / contact discharge 8 kV) Level 3 (10 V/m)
electrical fast transient/burst	IEC/EN 61000-4-4	Level 4 (4 kV / 2.5 kHz) Level 4 (4 kV / 5 kHz)
surge	IEC/EN 61000-4-5	L-L Level 3 (2 kV) / L-PE Level 4 (4 kV)
conducted disturbances, induced by radio-frequency fields	IEC/EN 61000-4-6	Level 3 (10 V)
power frequency magnetic fields	IEC/EN 61000-4-8	Level 4 (30 A/m)
voltage dips, short interruptions and voltage variations	IEC/EN 61000-4-11	dips: >95 % 0.5 ms / >30 % 0.5 ms interruptions: >95 % 250 ms
Interference emission		IEC/EN 61000-6-3
high-frequency radiated	IEC/CISPR 22, EN 55022	Class B
high-frequency conducted	IEC/CISPR 22, EN 55022	Class B
limits for harmonic current emissions	IEC/EN 61000-3-2	Class A

Approvals and marks on page 11.3.

CP-T Range

Technical data

Data at $T_a = 25\text{ °C}$, $U_{in} = 3 \times 400\text{ V AC}$ and rated values, unless otherwise indicated

Type	CP-T 48/5.0	CP-T 48/10.0	CP-T 48/20.0
Input circuit	L1, L2, L3		
Rated input voltage U_{in}	3 x 400-500 V AC		
Input voltage range	340-575 V AC 480-820 V DC		
Frequency range AC	47-63 Hz		
Typical input current	0.65 A	1.1 A	1.72 A
Typical power consumption	264 W	535 W	1050 W
Inrush current limiting	20 A		
Power failure buffering time	min. 20 ms		
Internal input fuse	per phase	2 A / 600 V AC	T 3.15 A / 500 V AC
Power factor correction (PFC)	yes, passive		
Discharge current	towards PE input / output	< 3.5 mA < 0.25 mA	
Indication of operational states			
Output voltage	OUTPUT OK: green LED OUTPUT LOW: red LED	output voltage OK output voltage too low	
Output circuit	L+, L+, L-, L-		
Rated output voltage	48 V DC		
Tolerance of the output voltage	0...+1 %		
Adjustment range of the output voltage	47-56 V DC		
Rated output power	240 W	480 W	960 W
Rated output current I _o	$T_a \leq 60\text{ °C}$ 5 A	10 A	20 A
Derating of the output current	$60\text{ °C} < T_a \leq 70\text{ °C}$	2.5 %/°C	
Maximum deviation with	load change statical	± 1 % (single mode) ± 5 % (parallel mode)	
Control time	change of output voltage within the input voltage range at rated load	± 0.5 % < 2 ms	
Starting time after applying the supply voltage	at I _o with 7000 µF	max. 1 s max. 1.5 s	
Rise time	at rated load with 7000 µF	max. 150 ms max. 500 ms	
Fall time		max. 150 ms	
Residual ripple and switching peaks	BW = 20 MHz	100 mV	80 mV
Parallel connection		configurable, to increase power, up to 2 devices, reduction: (number of devices x I _o) x 0.9	to increase power, up to 2 devices, reduction: (number of devices x I _o) x 0.9, use active current balancing
Series connection		yes, to increase voltage, max. 2 devices	
Resistance to reverse feed		approx. 35 V	approx. 63 V
			approx. 63 V
Output circuit - No-load, overload and short-circuit behavior			
Characteristic curve of output	combined U/I and hiccup mode	U/I or hiccup mode, configurable	hiccup mode / fold back behavior
Short-circuit protection	continuous short-circuit proof		
Short-circuit behavior	current limiting		
Overload protection	hiccup mode		
No-load protection	continuous no-load stability		
Over temperature protection	yes, automatic recovery after temperature went down		
Starting of capacitive loads	7000 µF		
General data			
Efficiency	typ. 91 %		typ. 93 %
Duty time	100%		
Dimensions (W x H x D)	89 x 124 x 118.8 mm [3.5 x 4.88 x 4.68 in]	150 x 124 x 118.8 mm [5.91 x 4.88 x 4.68 in]	275.8 x 124 x 118.8 mm [10.86 x 4.88 x 4.68 in]
Weight	1.045 kg (2.30 lb)	1.657 kg (3.653 lb)	3.275 kg (7.22 lb)
Material of housing	Metal		
Mounting	DIN rail (IEC EN 60715), snap-on mounting without any tool		
Mounting position	horizontal		
Minimum distance to other units	horizontal / vertical	25 mm / 25 mm (0.98 in / 0.98 in)	
Degree of protection	housing / terminals	IP20 / IP20	
Protection class	I		

CP-T Range

Technical data

Data at $T_a = 25\text{ °C}$, $U_n = 3 \times 400\text{ V AC}$ and rated values, unless otherwise indicated

Type		CP-T 48/5.0	CP-T 48/10.0	CP-T 48/20.0
Wire size	fine-strand with wire end ferrule	0.2-4 mm ² (24-11 AWG)		0.2-4 mm ² (24-11 AWG) / 0.5-10 mm ² (20-6 AWG)
	fine-strand without wire end ferrule	0.2-6 mm ² (24-10 AWG)		
	rigid			
Stripping length		8 mm (0.31 in)		
Tightening torque	input / output	1 Nm / 0.6 Nm		1 Nm / 1.8 Nm

Environmental data

Ambient temperature range	operation	-40...+70 °C	-30...+70 °C	-40...+70 °C
	rated load	-40...+70 °C	-30...+60 °C	-40...+70 °C
	storage	-40...+70 °C	-40...+85 °C	-40...+70 °C
Damp heat (cyclic) (IEC/EN 60068-2-30)		95 % without condensation		
Vibration (sinusoidal) (IEC/EN 60068-2-6)		10-500 Hz, 2G, each along X, Y, Z axes 6 min / cycle		
Shock (half-sine) (IEC/EN 60068-2-27)		Half sine wave, 15G, 11 ms, 3 axes, 6 Faces, 3 times for each face		

Isolation data

Rated insulation voltage U_i	input circuit / output circuit	3 kV AC		
	input / PE	1.5 kV AC		
Pollution degree		2		

Standards

Product standard	IEC/EN 61204-3			
Low Voltage Directive	2006/95/EC			
EMC directive	2004/108/EC			
RoHS directive	2002/95/EC			
Electrical safety	EN 60950-1, UL 60950-1, UL 508, EN 61558-1, EN 61558-2-17; EN 60204-1			
Protective low voltage	SELV			

Electromagnetic compatibility

Interference immunity to		IEC/EN 61000-6-2		
electrostatic discharge	IEC/EN 61000-4-2	Level 4 (air discharge 15 kV / contact discharge 8 kV)		
radiated, radio-frequency, electromagnetic field	IEC/EN 61000-4-3	Level 3 (10 V/m)		
electrical fast transient/burst	IEC/EN 61000-4-4	Level 4 (4 kV / 5 kHz)		
surge	IEC/EN 61000-4-5	L-L Level 3 (2 kV) / L-PE Level 4 (4 kV)		
conducted disturbances, induced by radio-frequency fields	IEC/EN 61000-4-6	Level 3 (10 V)		
power frequency magnetic fields	IEC/EN 61000-4-8	Level 4 (30 A/m)		
voltage dips, short interruptions and voltage variations	IEC/EN 61000-4-11	dips: >95 % 0.5 ms / >30 % 0.5 ms interruptions: >95 % 250 ms		
Interference emission		IEC/EN 61000-6-3		
high-frequency radiated	IEC/CISPR 22, EN 55022	Class B		
high-frequency conducted	IEC/CISPR 22, EN 55022	Class B		
limits for harmonic current emissions	IEC/EN 61000-3-2	Class A		

Approvals and marks on page 11.3.

CP-T Range

Technical diagrams

Approximate dimensions

Technical diagrams

dimensions in mm

Output curve at $T_{ij} = 25\text{ }^{\circ}\text{C}$

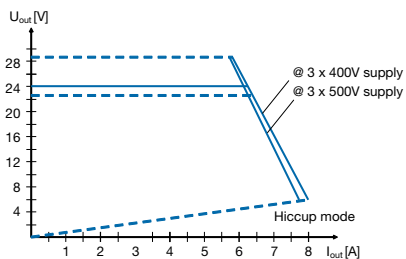

CP-T 24/5.0

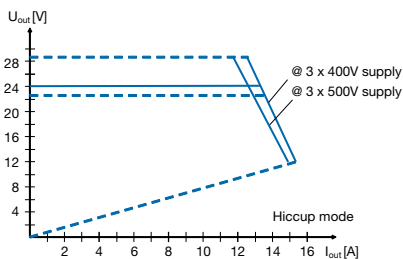

CP-T 24/10.0

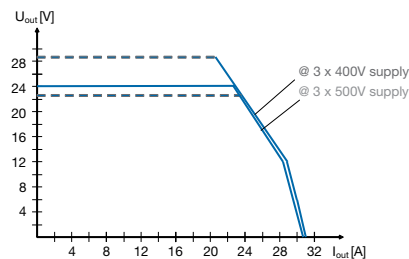

CP-T 24/20.0 U/I curve

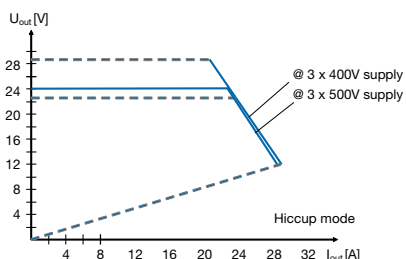

CP-T 24/20.0 Hiccup mode

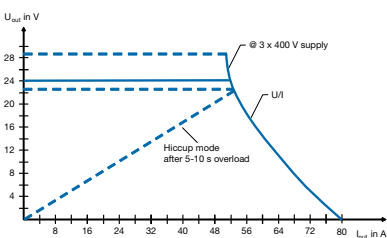

CP-T 24/40.0

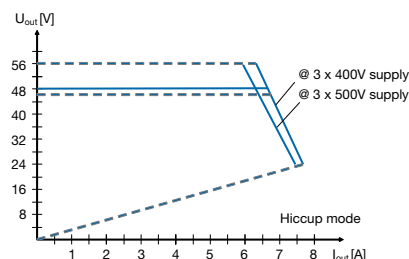

CP-T 48/5.0

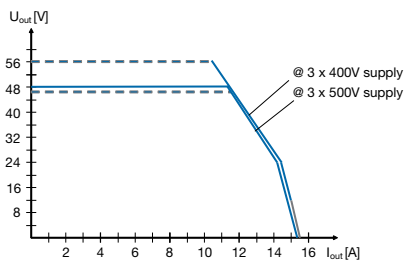

CP-T 48/10.0 U/I curve

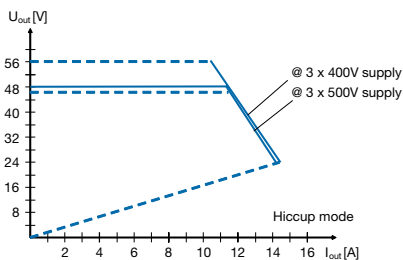

CP-T 48/10.0 Hiccup mode

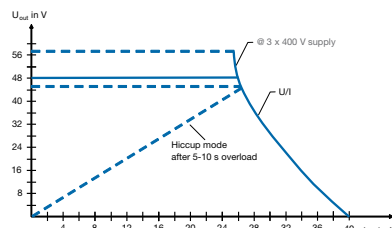

CP-T 48/20.0

Approximate dimensions

dimensions in mm

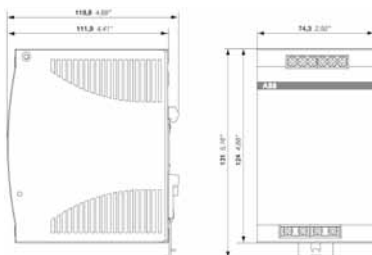

CP-T 24/5.0

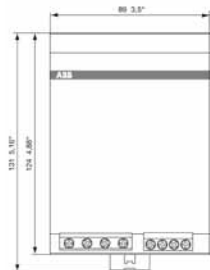

CP-T 24/10.0, CP-T 48/5.0 Low

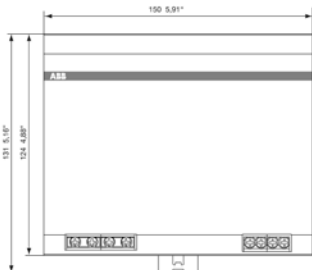

CP-T 24/20.0, CP-T 48/10.0



CP-T 24/40.0, CP-T 48/20.0

CP-T Range

Technical diagrams

Temperature curve at rated load

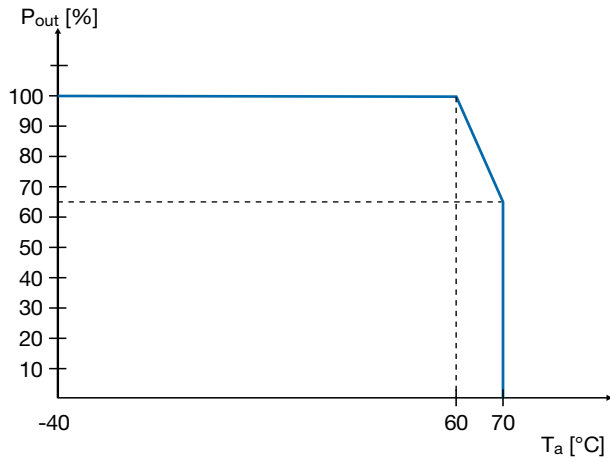

CP-T 24/40.0, CP-T 48/20.0

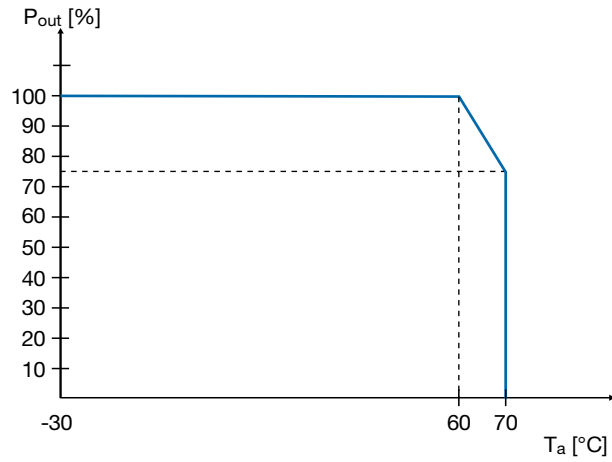

CP-T 24/20.0, CP-T 48/10.0

11

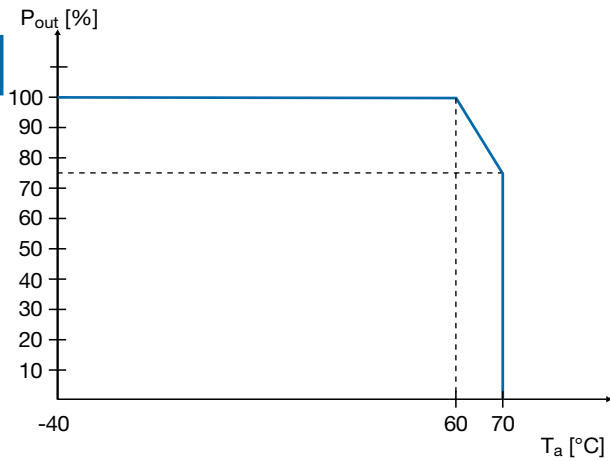

CP-T 24/10.0, CP-T 24/5.0, CP-T 48/5.0

Type CP-S, CP-C & CP-A Switch mode Power supplies



Switch mode power supplies CP-S, CP-C & CP-A Range



Characteristics CP-S and CP-C range

- Output current 5 A, 10 A and 20 A
- Integrated power reserve of up to 50 %
- 5 A and 10 A devices with pluggable connecting terminals
- Approvals / marks (depending on device, partly pending)



CP-S range

- 10 A and 20 A device with front-face selector switch to adjust rated input voltage range: 110-120 V AC or 220-240 V AC
- Output voltage fixed at 24 V DC
- Parallel operation for redundancy

CP-C range

- Wide range input 110-240 V AC (85-264 V AC, 100-350 V DC)
- Output voltage adjustable in a range of 22-28 V DC
- Parallel operation for increased capacity and redundancy
- Power factor correction (PFC) acc. to EN 61000-3-2
- Function module pluggable onto the front side

Messaging module CP-C MM:

- LED for status indication
- Relay outputs "Input OK" and "Output OK"
- REMOTE ON/OFF function to switch on and off the power supply externally
- Output voltage monitoring is only possible in decoupled parallel operation

CP-A range

Redundancy unit CP-A RU

- Redundancy unit with 2 inputs / channels for decoupling of 2 CP-S or 2 CP-C power supplies up to 20 A per input / channel and output up to 40 A
- True redundancy by 100 % decoupling with 2 integrated diodes

Control module CP-A CM

- Pluggable onto redundancy unit CP-A RU
- One relay output per monitored input / channel
- Threshold values adjustable (14-28 V)
- Indicates the presence of both input voltages (of the CP-A RU) via LEDs and energized output relays

Benefits

Integrated power reserve

The new CP-S and CP-C range power supplies feature an integrated power reserve of up to 50 %. No oversized electricity supply is needed, especially under heavy load conditions.

Pluggable connecting terminals

Extended flexibility in operation due to pluggable connecting terminals (this feature is not offered on all devices).

Adjustable output voltage

The CP-C range types feature a continuously adjustable output voltage from 22 to 28 V. Thus, they can be optimally adapted to the application, e.g. compensating the voltage drop caused by long line length.

Pluggable function modules

The CP-C range power supplies can be equipped with pluggable modules to add additional functions (e.g. messaging module). Thus, the power supplies can be ideally adapted to the relevant application.

CP-S, CP-C & CP-A Range

Ordering details

Description

The power supply units in the CP-S and CP-C range are ABB's high-end solutions. Designed with an integrated 50 % power reserve and an efficiency of approximately 89 % these are the perfect products for all complex, highly reliable applications. All the devices cover the U-I output characteristic and are built with thermal protection which switches off in case of overheating. In particular, the devices of the CP-C range feature a much broader functionality, including active power factor correction and pluggable function modules.

These products are designed to trip MCB's in the 24VDC output circuit. Coordination tables are available.



CP-S 24/5.0



CP-C 24/10.0



CP-S 24/20.0



CP-A RU + CP-A CM

Ordering details

Input voltage range	Rated output voltage / current	Type	Catalog number	Weight (1 pce) kg (lb)
85-264 V AC / 110-350 V DC	24 V DC / 5 A	CP-S 24/5.0	1SVR427014R0000	0.96 (2.11)
85-132 V AC, 184-264 V AC / 220-350 V DC	24 V DC / 10 A	CP-S 24/10.0	1SVR427015R0100	1.07 (2.35)
85-132 V AC, 184-264 V AC / 220-350 V DC	24 V DC / 20 A	CP-S 24/20.0	1SVR427016R0100	2.83 (6.23)
85-264 V AC / 110-350 V DC	24 V DC / 5 A	CP-C 24/5.0	1SVR427024R0000	0.96 (2.11)
85-264 V AC / 110-350 V DC	24 V DC / 10 A	CP-C 24/10.0	1SVR427025R0000	1.34 (2.95)
85-264 V AC / 110-350 V DC	24 V DC / 20 A	CP-C 24/20.0	1SVR427026R0000	3.15 (6.94)

Description	Type	Catalog number	Weight (1 pce) kg (lb)
Messaging module for CP-C range power supplies	CP-C MM	1SVR427081R0000	0.065 (0.14)
Redundancy unit	CP-A RU	1SVR427071R0000	0.89 (1.96)
Control module for CP-A RU redundancy units	CP-A CM	1SVR427075R0000	0.063 (0.14)

CP-S, CP-C & CP-A Range

Technical data

Data at $T_a = 25\text{ }^\circ\text{C}$, $U_{in} = 230\text{ V AC}$ and rated values, unless otherwise indicated

Type		CP-C 24/5.0 CP-S 24/5.0	CP-C 24/10.0 CP-S 24/10.0	CP-C 24/20.0 CP-S 24/20.0
Input circuit - supply circuit		L, N		
Rated input voltage U_{in}	CP-C	110-240 V AC		
	CP-S	switch position 115 switch position 230	110-240 V AC	110-120 V AC 220-240 V AC
Input voltage range	CP-C	85-264 V AC / 100-350 V DC ¹⁾		
	CP-S	switch position 115 switch position 230	85-264 V AC / 100-350 V DC ¹⁾	85-132 V AC 184-264 V AC / 220-350 V DC ¹⁾
Frequency range AC		47-63 Hz		
Typical input current		CP-C at 110-240 V AC CP-S at 110-120 V AC CP-S at 220-240 V AC	approx. 2.2-1.2 A - -	approx. 2.6-1.2 A approx. 4.2-4.0 A approx. 2.4-2.2 A
Power consumption			typ. 135 W	typ. 269 W typ. 538 W
Inrush current limiting / I ² t (cold start)	CP-C CP-S		< 23 A / approx. 0.9 A ² s	< 33 A / approx. 0.2 A ² s < 40 A / approx. 1.8 A ² s < 40 A / approx. 1.9 A ² s < 70 A / approx. 8 A ² s
Power failure buffering time			min. 100 ms	min. 40 ms min. 40 ms
Transient overvoltage protection				varistors
Internal input fuse (apparatus protection, not accessible)			4 A (slow-acting)	6.3 A (slow-acting) 12 A (fast-acting)
Power factor correction (PFC)	CP-C CP-S			yes, active no

Indication of operational states

Output voltage	OUTPUT OK: green LED	 : output voltage OK
----------------	----------------------	---

Output circuit

		L+, L+, L-, L- : short-circuit, no-load and overload proof		
Rated output voltage		24 V DC		
Tolerance of the output voltage	CP-C CP-S	±1 % -1...+5 %		
Adjustment range of the output voltage	CP-C CP-S	22-28 V DC, default setting 24 V ±0.5 % fixed		
Rated output power		120 W	240 W	480 W
Rated output current	$T_a \leq 60\text{ }^\circ\text{C}$	5 A	10 A	20 A
Peak output current (power reserve)	$T_a \leq 40\text{ }^\circ\text{C}$	typ. ≤ 7.25 A	typ. ≤ 12.25 A	typ. ≤ 22.5 A
Derating	$60\text{ }^\circ\text{C} < T_a \leq 70\text{ }^\circ\text{C}$	2.5 % per Kelvin temperature increase		
Deviation with	CP-C load change statical 10-90 % CP-S load change statical 10-90 % load change dynamical 10-90 % change of the input voltage of ±10 %	typ. < ±0.05 % typ. < ±0.1 % typ. < ±3 % typ. < ±0.05 %		
Control time		typ. < 1 ms		
Starting time after applying supply voltage	CP-C CP-S	< 200 ms	< 200 ms < 250 ms	typ. < 200 ms typ. < 300 ms
Rise time 10-90 %	CP-C CP-S	typ. < 30 ms	typ. < 4 ms typ. < 5 ms	typ. < 12 ms typ. < 15 ms
Residual ripple and switching peaks	BW = 20 MHz	typ. < 50 mV _{pp}		
Parallel connection		yes, up to 5 devices, to enable redundancy and to increase power, current not symmetrical (CP-S only redundancy)		
Series connection		yes, to increase voltage		
Resistance to reverse feed		approx. 35 V DC		

Output circuit - No-load, overload and short-circuit behavior

		see also U/I- and I/T-characteristic curves		
Characteristic curve of output		U/I characteristic curve with power reserve		
Current limiting at short circuit		approx. 11 A	approx. 19 A	approx. 25 A
Short-circuit protection		continuous short-circuit stability		
Overload protection		thermal protection		
Starting of capacitive loads		unlimited		

General data

Power dissipation		typ. < 15 W	typ. < 29 W	typ. < 58 W
Efficiency		typ. 89 %		
Discharge current for PE		< 3.5 mA		
MTBF	CP-C CP-S	500.000 h 350.000 h		
Dimensions (W x H x D)		56.5 (60 ²⁾ x 130 x 135.5 mm [2.22 (2.36 ²⁾ x 5.12 x 5.35 in]	90 (93.5 ²⁾ x 130 x 135.5 mm [3.54 (3.68 ²⁾ x 5.12 x 5.35 in]	200 (203.5 ²⁾ x 130 x 135.5 mm [7.87 (8.01 ²⁾ x 5.12 x 5.35 in]
Weight	CP-C CP-S	approx. 0.96 kg (2.12 lb)	approx. 1.34 kg (2.95 lb) approx. 1.07 kg (2.36 lb)	approx. 3.15 kg (6.94 lb) approx. 2.83 kg (6.23 lb)
Minimum distance to other units	horizontal / vertical	10 mm / 80 mm (0.39 in / 3.15 in)		
Degree of protection	housing / terminals	IP20 / IP20		
Material of housing	housing shell / cover	aluminium / zinc-coated sheet steel		

CP-S, CP-C & CP-A Range

Technical data

Data at $T_a = 25\text{ °C}$, $U_n = 230\text{ V AC}$ and rated values, unless otherwise indicated

Type	CP-C 24/5.0 CP-S 24/5.0	CP-C 24/10.0 CP-S 24/10.0	CP-C 24/20.0 CP-S 24/20.0
Protection class (EN 61140)	I		
Mounting	DIN rail (IEC/EN 60715), snap-on mounting		
Mounting position	horizontal		
Electrical connection - Input circuit			
Wire size	³⁾	³⁾	-
fine-strand with wire end ferrule	0.2-2.5 mm ² (24-14 AWG)		2.5-10 mm ² (14-8 AWG)
fine-strand without wire end ferrule			0.5-10 mm ² (20-8 AWG)
rigid			0.5-16 mm ² (20-6 AWG)
Stripping length	7 mm (0.28 in)		12 mm (0.47 in)
Tightening torque	0.4 Nm		1.2-1.5 Nm
Electrical connection - Output circuit			
Wire size	³⁾	³⁾	-
fine-strand with wire end ferrule	0.12-2.5 mm ² (26-14 AWG)		2.5-10 mm ² (14-8 AWG)
fine-strand without wire end ferrule			0.5-10 mm ² (20-8 AWG)
rigid			0.5-16 mm ² (20-6 AWG)
Stripping length	8 mm (0.31 in)		12 mm (0.47 in)
Tightening torque	0.4 Nm		1.2-1.5 Nm
Environmental data			
Ambient temperature range	operation	-25...+70 °C	
	rated load	0...+60 °C (without derating)	
	storage	-40...+85 °C	
Damp heat (IEC/EN 60068-2-3)	93 % at +40 °C, no condensation		
Climatic category (IEC/EN 60721)	3K3		
Vibration (IEC/EN 60068-2-6)			
Shock (IEC/EN 60068-2-27)			
Isolation data			
Rated insulation voltage U_i between all isolated circuits (IEC/EN 60950-1; EN 50178)	input / output	300 V	
	input / PE	300 V	
	output / PE	50 V	
Rated impulse withstand voltage U_{imp} between all isolated circuits (IEC/EN 60950-1; EN 50178)	input / output	4 kV; 1.2/50 μ s	
	input / PE	2.5 kV; 1.2/50 μ s	
	output / PE	500 V; 1.2/50 μ s	
Power-frequency withstand voltage test (test voltage) (routine test / type test)	input / output	1.5 kV AC / 3.0 kV AC	
	input / PE	1.5 kV AC / 3.0 kV AC	
	output / PE	500 V DC / 500 V DC	
Pollution degree (IEC/EN 60950-1; EN 50178)	2		
Overvoltage category (IEC/EN 60950-1; EN 50178)	II		
Standards			
Product standard	IEC/EN 61204		
Low Voltage Directive	2006/95/EC		
EMC Directive	2004/108/EC		
Electrical safety	EN 50178, EN 60950, UL 60950, UL 508		
Protective low voltage	SELV (EN 60950)		
Electromagnetic compatibility			
Interference immunity to	IEC/EN 61000-6-2		
electrostatic discharge	IEC/EN 61000-4-2	Level 4 (8 kV / 15 kV)	
radiated, radio-frequency, electromagnetic field	IEC/EN 61000-4-3	Level 3 (10 V/m)	
electrical fast transient / burst	IEC/EN 61000-4-4	Level 4 (4 kV)	
surge	IEC/EN 61000-4-5	Level 4 (2 kV symmetrical, level 3 - 3 kV asymmetrical)	
conducted disturbances, induced by radio-frequency fields	IEC/EN 61000-4-6	Level 3 (10 V)	
Interference emission	IEC/EN 61000-6-3		
high-frequency radiated	IEC/CISPR 22; EN 55022	Class B	
high-frequency conducted	IEC/CISPR 22; EN 55022	Class B	

¹⁾ at $U > 264\text{ V}$ use additionally an appropriate external fuse

²⁾ with lateral screw

³⁾ pluggable connecting terminals, actuate only when power is off

Approvals and marks on page 11.3.

CP-S, CP-C & CP-A Range

Technical data

Data at Ta = 25 °C, Uin = 230 V AC and rated values, unless otherwise indicated

Type	CP-C MM	
Input circuit - Supply circuit		
Rated input voltage Uin	powered by the output circuit of the power supply	
Input voltage range	70-264 V AC / 80-350 V DC	
Power consumption	2.5 VA / 1.5 W	
Input circuit - Control circuit		
Kind of triggering	volt-free triggering	
Control input, control function	Remote OFF	remote off
Threshold "Switching-off power supply unit"	R m 1 k Ω	
Threshold "Switching-on power supply unit"	R M 10 k Ω	
Input current	typ. 1 mA (200 mA for 200 μ s)	
Maximum cable length to the control input	25 m - 100 pF/m	
Measuring circuit - INPUT		
Monitoring function	undervoltage monitoring of input voltage of the power supply unit	
Thresholds	85 V AC / 90 V DC	
Hysteresis, related to the threshold value	AC: typ. -8 % / DC -30 %	
Accuracy, tolerance	-5 % at AC and DC	
Maximum measuring cycle	typ. < 50 ms	
Measuring circuit - OUTPUT		
Monitoring function	undervoltage monitoring of output voltage of the power supply unit	
Thresholds	20 V DC	
Hysteresis, related to the threshold value	typ. 5 %	
Accuracy, tolerance	\pm 1 %	
Maximum measuring cycle	typ. < 10 ms	
Indication of operational states		
Remote off	REMOTE OFF: green LED	"REMOTE OFF" input R m 1k Ω
Status of power supply input	Input OK: green LED	relay "INPUT OK" energized
Status of power supply output	OUTPUT OK: green LED	relay "OUTPUT OK" energized
Output circuits		
Kind of output	11-12/14, 21-22/24	
Operating principle	relays, 2 x 1 c/o contacts	
Contact material	closed-circuit principle	
Rated voltage (VDE 0110, IEC/EN 60947-1)	AgNi	
Minimum switching voltage / Minimum switching current	250 V	
Maximum switching voltage / Maximum switching current	24 V / 10 mA	
Rated operating current Ie (IEC/EN 60947-1)	AC12 (resistive) at 230 V	250 V / 1 A
	AC15 (inductive) at 230 V	1 A
	DC12 (resistive) at 24 V	1 A
	DC13 (inductive) at 24 V	1 A
Mechanical lifetime	30 x 10 ⁶ switching cycles	
Electrical lifetime	0.1 x 10 ⁶ switching cycles	
Short circuit proof, maximum fuse rating	n/c contact	2 A, gL
	n/o contact	2 A, gL
General data		
Duty time	100 %	
Dimensions (W x H x D, when mounted)	56.5 x 54 x 24 mm (2.22 x 2.13 x 0.94 in)	
Weight	0.065 kg (0.14 lb)	
Degree of protection	housing / terminals	IP20 / IP20
Material of housing	Plastic	
Protection class (EN 61140)	II	
Mounting	snap-on mounting, without any tool	
Mounting position	plugged onto the power supply unit	
Electrical connection		
Wire size	fine-strand with wire end ferrule	0.2-2.5 mm ² (24-14 AWG)
	fine-strand without wire end ferrule	
	rigid	
Stripping length	0.2-4 mm ² (24-12 AWG)	
Tightening torque	7.5 mm (0.3 inch)	
Environmental data	0.4-0.6 Nm	
Ambient temperature range	operation	-25...+70 °C
	storage	-40...+85 °C

CP-S, CP-C & CP-A Range

Technical data

Data at Ta = 25 °C, Uin = 230 V AC and rated values, unless otherwise indicated

Type	CP-C MM	
Damp heat (IEC/EN 60068-2-3)	93 % at +40 °C, no condensation	
Climatic category (IEC/EN 60721)	3K3	
Vibration (IEC/EN 60068-2-6)		
Shock (IEC/EN 60068-2-27)		
Isolation data		
Rated insulation voltage Ui (IEC/EN 60974-1, EN 50178, VDE 0160)	250 V	
Protective separation (EN 50178, EN 60950) supply / measuring circuits / relay outputs	yes	
Rated impulse withstand voltage Uimp between all isolated circuits (IEC 664, VDE 0110)	4 kV; 1.2/50 µs	
Test voltage between all circuits (type test)	2.5 kV AC	
Pollution degree (EN 60950)	2	
Overvoltage category (EN 60950)	II	
Standards		
Product standard	IEC/EN 61204	
Low Voltage Directive	2006/95/EC	
EMC Directive	2004/108/EC	
Electrical safety	EN 50178, EN 60950, UL 60950, UL 508	
Electromagnetic compatibility		
Interference immunity to	IEC/EN 61000-6-2	
electrostatic discharge	IEC/EN 61000-4-2	Level 3 and 4 (6 kV / 8 kV)
radiated, radio-frequency, electromagnetic field	IEC/EN 61000-4-3	Level 3 (10 V/m)
electrical fast transient / burst	IEC/EN 61000-4-4	Level 4 and 2 (4 kV power input / 1 kV control input)
surge	IEC/EN 61000-4-5	Level 3 and 2 (4 kV symmetrical power input / 1 kV control input)
conducted disturbances, induced by radio-frequency fields	IEC/EN 61000-4-6	Level (10 V)
Interference emission	IEC/EN 61000-6-3	
high-frequency radiated	IEC/CISPR 22; EN 55022	Class B
high-frequency conducted	IEC/CISPR 22; EN 55022	Class B

Approvals and marks on page 11.3.

CP-S, CP-C & CP-A Range

Technical data

Data at Ta = 25 °C, unless otherwise indicated

Type		CP-A RU	CP-A RU in combination with CP-A CM
Input circuit - Supply circuit			(+/-, +/-)
Rated input voltage U _{in}			24 V DC
Input voltage range per channel		10-28 V DC	13-28 V DC
Rated input current I _{in} per channel			1-20 A
Maximum input current per channel			30 A for 300 s
Transient overvoltage protection			yes
Output circuit			(+/-)
Rated output voltage U _{out}			24 V DC
Voltage drop			typ. 0.6 V, max. 0.9 V
Rated output current I _{out}			1-40 A
Output ratings per channel	Ta = 60 °C	10-28 V DC / 40 A	13-28 V DC / 40 A
	Ta = 70 °C	10-28 V DC / 30 A	13-28 V DC / 30 A
Derating	60 °C < Ta m 70 °C	2.5 % per Kelvin temperature increase	
Peak output current			60 A for 300 s
Resistance to reverse feed			< 40 V
General data			
Dimensions (W x H x D)		56.5 (60 1)) x 130 x 135.5 mm; (2.22 (2.36 1)) x 5.12 x 5.35 in)	
Weight		0.89 kg (1.96 lb)	
Minimum distance to other units	horizontal / vertical	10 mm / 50 mm (0.39 in / 1.97 in)	
Degree of protection	housing / terminals	IP20 / IP20	
Material of housing	housing shell / cover	aluminium / zinc-coated sheet steel	
Protection class		III 2)	
Mounting		DIN rail (IEC/EN 60715)	
Mounting position		horizontal	
Electrical connection - Input circuit / Output circuit			
Wire size	fine-strand with wire end ferrule	2.5-10 mm ² (14-8 AWG)	
	fine-strand without wire end ferrule	0.5-10 mm ² (20-8 AWG)	
	rigid	0.5-16 mm ² (20-6 AWG)	
Stripping length		12 mm (0.47 in)	
Tightening torque		1.2-1.5 Nm	
Environmental data			
Ambient temperature range	operation	-25...+70 °C	
	rated load	-25...+60 °C (without derating)	
	storage	-40...+85 °C	
Damp heat (IEC/EN 60068-2-3)		93 % at 40 °C, no condensation	
Climatic category (IEC/EN 60721)		3K3	
Vibration (IEC/EN 60068-2-6)			
Shock (IEC/EN 60068-2-27)			
Isolation data			
Insulation voltage	between input / output / housing	500 V AC (routine test)	
Pollution degree (EN 50178)		2	
	Standards		
Product standard		IEC/EN 61204	
Low Voltage Directive		2006/95/EC	
EMC Directive		2004/108/EC	
Electrical safety		EN 50178, EN 60950, UL 60950, UL 508	
Electromagnetic compatibility			
Interference immunity to		IEC/EN 61000-6-2	
electrostatic discharge	IEC/EN 61000-4-2	Level 3 (air discharge ±8 kV, contact discharge ±6 kV)	
radiated, radio-frequency, electromagnetic field	IEC/EN 61000-4-3	Level 3 (10 V/m)	
electrical fast transient / burst	IEC/EN 61000-4-4	Level 3 (±2 kV)	
surge	IEC/EN 61000-4-5	Level 1 (±0.5 kV)	
conducted disturbances, induced by radio-frequency fields	IEC/EN 61000-4-6	Level 3 (10 V)	
Interference emission		IEC/EN 61000-6-3	
high-frequency radiated	IEC/CISPR 22 / EN 55022	Class B	
high-frequency conducted	IEC/CISPR 22 / EN 55022	Class B	

¹⁾ incl. lateral screw

²⁾ This device is designed for connection to a safety extra-low voltage source. If no safety extra-low voltage is used at the input side, the lateral screw can be used for grounding of the housing (protection class I).

Approvals and marks on page 11.3.

CP-S, CP-C & CP-A Range

Technical data

Data at Ta = 25 °C, unless otherwise indicated

Type		CP-A CM
Input circuit - Supply circuit		
Rated input voltage U _{in}		24 V DC
Input voltage range		13-28 V DC
Rated input current	at rated sense load and 24 V DC	120 mA
Power consumption	at 24 V DC	approx. 1 W
Measuring circuit		
Monitoring function		11-12/14, 21-22/24 undervoltage monitoring
Measuring voltage		rated operational voltage
Thresholds		14-28 V
Hysteresis, related to the threshold value		fix: 3-5 %
Accuracy, tolerance		10 % of full-scale value
Maximum measuring cycle		6 ms
Indication of operational states		
Status of input 1	IN 1: green LED	L: voltage at input 1 > than threshold 1 = no faults present
Status of input 2	IN 2: green LED	L: voltage at input 2 > than threshold 2 = no faults present
Output status	OUT: green LED	L: U _{OUT} > 3 V = no faults present
Output circuit		
Kind of output		+, +, - relays, 2 x 1 c/o contact
Contact material		AgNi
Operating principle		closed-circuit principle
Rated operational voltage U _e (IEC/EN 60947-1, VDE 0110)		250 V
Minimum switching voltage / Minimum switching current		24 V / 10 mA
Maximum switching voltage / Maximum switching current		250 V / 1 A
Rated operational current I _e (IEC/EN 60947-5-1)	AC12 (resistive) at 230 V	1 A
	AC15 (inductive) at 230 V	1 A
	DC12 (resistive) at 24 V	1 A
	DC13 (inductive) at 24 V	1 A
Mechanical lifetime		30 x 106 switching cycles
Electrical lifetime		0.1 x 106 switching cycles
Rating according UL 508	General purpose (GP) 250 V AC	1 A
Maximum fuse rating to achieve short-circuit protection	n/o contact	2 A, gL
	n/c contact	2 A, gL
Sense output (+, +, -)		
Sense output voltage		1 SVR 427 075 R0000 13-28 V DC
Sense output current		0.1 A
Maximum fuse rating		For applications acc. UL the sense output shall be provided with a listed DC fuse 3 A
General data		
Duty time		100 %
Dimensions (W x H x D, when mounted)		56.5 x 54 x 24 mm (2.22 x 2.13 x 0.94 in)
Weight		0.063 kg (0.14 lb)
Degree of protection	housing / terminals	IP20 / IP20
Protection class		II
Mounting		snap-on mounting, without any tool
Mounting position		plugged onto the redundancy unit CP-A RU
Electrical connection		
Wire size	fine-strand with wire end ferrule	0.2-2.5 mm ² (24-14 AWG)
	fine-strand without wire end ferrule	
	rigid	0.2-4 mm ² (24-12 AWG)
Stripping length		7.5 mm (0.3 in)
Tightening torque		0.4-0.6 Nm
Isolation data		
Rated insulation voltage U _i (IEC/EN 60947-1, EN 50178, VDE 0160)		250 V
Rated impulse withstand voltage U _{imp} (type test) between all circuits (IEC 664, VDE 0110)		2.5 kV
Power-frequency withstand voltage test (routine test) between all circuits		1.2 kV AC
Protective separation (EN 50178) between input and output		yes
Pollution degree		2
Overvoltage category		II
Environmental data		
Ambient temperature range	operation	-25...+70 °C
	storage	-40...+85 °C
Damp heat (IEC/EN 60068-2-3)		93 %at 40 °C, no condensation
Climatic category (IEC/EN 60721)		3K3
Vibration (IEC/EN 60068-2-6)		
Shock (IEC/EN 60068-2-27)		

CP-S, CP-C & CP-A Range

Technical diagrams, Approximate dimensions

Technical diagrams

Output curve at 25 °C

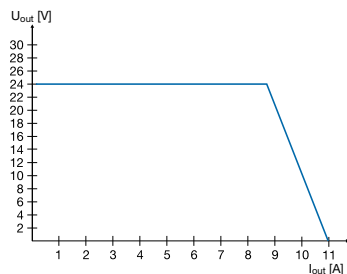

CP-S 24/5.0

Output curve at 25 °C

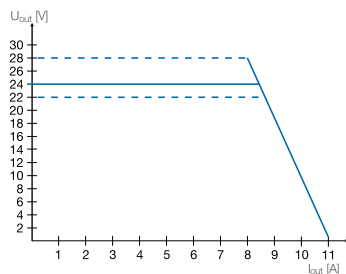

CP-C 24/5.0

Temperature curve at $U_{out} = 24 \text{ V DC}$

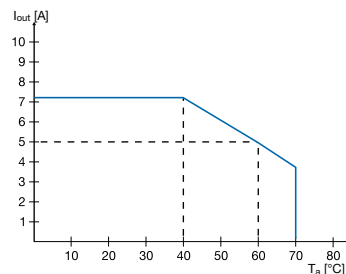

CP-S 24/5.0, CP-C 24/5.0

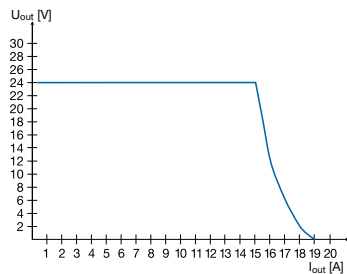

CP-S 24/10.0

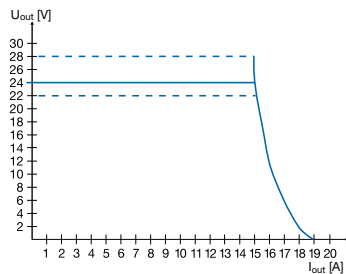

CP-C 24/10.0

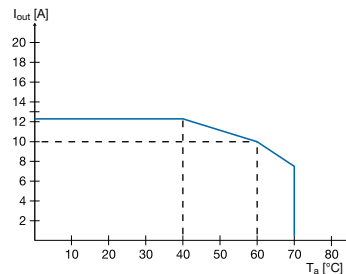

CP-S 24/10.0, CP-C 24/10.0

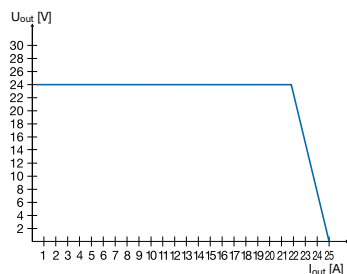

CP-S 24/20.0

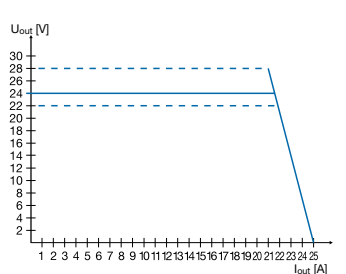

CP-C 24/20.0

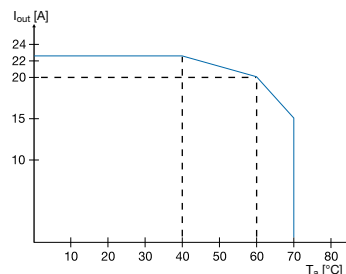

CP-S 24/20.0, CP-C 24/20.0

Approximate dimensions

dimensions in mm

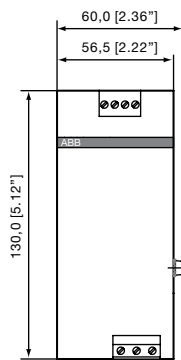
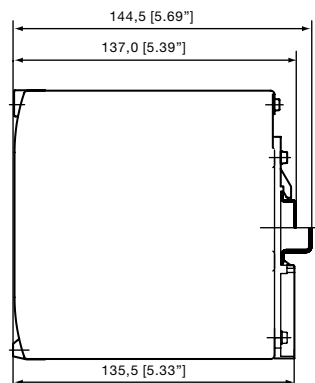

CP-S 24/5.0
CP-C 24/5.0
CP-A RU

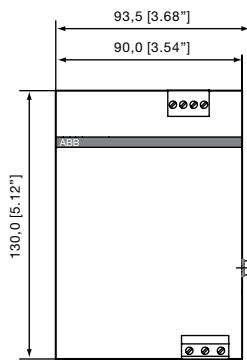

CP-S 24/10.0
CP-C 24/10.0

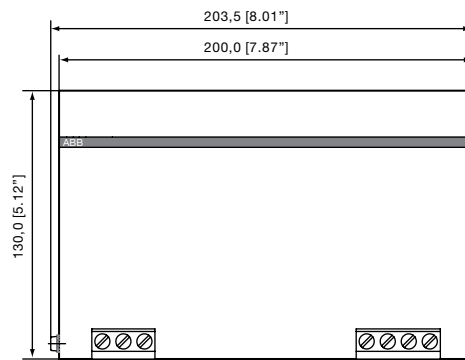

CP-S 24/20.0
CP-C 24/20.0

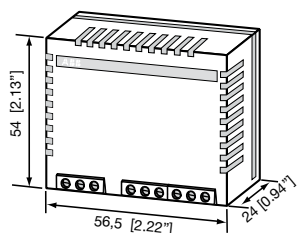

CP-C MM
CP-A CM



Switch mode power supplies CP-B Range



Type CP-B Switch mode Power supplies

Power supply systems have to be highly reliable in most areas of energy management and automation technology.

Often batteries are used for supporting the supply system in case of mains failures. Batteries have limited lifetimes depending on environmental parameters and have to be maintained regularly, which causes efforts and costs.

Using the latest ultra-capacitor technology, ABB offers an innovative and completely maintenance free new product for buffering the 24 V DC supply in case of interrupted mains on the primary side of the switch mode power supply.

The CP-B range is an ultra-capacitor buffer energy storage for power supply units which ensures a short term uninterrupted power supply system. In case of a power loss, the energy stored in the capacitor guarantees that the load is continually provided up to several hundred seconds depending on the load current.

Characteristics

- 3 buffer modules for buffering 24 V DC:
CP-B 24/3.0 (3 A / 1 kW_{s1})
CP-B 24/10.0 (10 A / 10 kW_{s1})
CP-B 24/20.0 (20 A / 8 kW_{s1})
 - CP-B 24/3.0 and CP-B 24/20.0 expandable with additional extension module(s) CP-B EXT.2 (2 kW_{s1})
 - LEDs for status indication
 - Relay contacts for status messaging
 - Very high backup times (e.g. with CP-B 24/10.0 up to 8 minutes at 1 A load current)
 - Short charging times
 - High efficiency, higher than 90%
 - Wide temperature range
 - DIN rail mountable, compact housing
 - Advantages in comparison to battery buffers
 - Maintenance free
 - No deep discharge
 - Temperature resistant
 -  approval (UL508, CSA22.2 No 14)
- 1) internal energy buffer

	CP-B 24/3.0	CP-B 24/10.0	CP-B 24/20.0	CP-B EXT.2
Catalog number	1SVR427060R0300	1SVR427060R1000	1SVR427060R2000	1SVR427065R0000
Rated input voltage	24 V DC	24 V DC	24 V DC	-
Rated current	3 A DC	10 A DC	20 A DC	3 A DC
Energy storage (min.)	1.000 Ws	10.000 Ws	8.000 Ws	2.000 Ws
Typical charging time at load current	100 %	65 s	134 s	135 s
	0 %	56 s	82 s	62 s
Typical buffering time ¹⁾ at load current	100 %	13 s	38 s	15 s
	50 %	28 s	76 s	30 s
	25 %	66 s	140 s	60 s
	10 %	148 s	380 s	150 s

¹⁾ buffering time = $\frac{\text{energy storage} \times 0.9}{\text{current} \times \text{output voltage}}$

CP-B Range

Ordering data

Description

Ultra capacitor based buffer units of the CP-B range offer highest reliability also in harsh environment. Due to the ultra-cap based technology the units are maintenance free, there will be no deep discharge and these products offer a very wide operational ambient temperature range.

CP-B range buffer units are an excellent solution to avoid voltage drops, for example in solar applications.



CP-B 24/3.0



CP-B 24/10.0



CP-B 24/20.0

Ordering details

Rated input voltage	Rated current	Type	Catalog number	Weight (1 pce) kg (lb)
24 V DC	3 A DC	CP-B 24/3.0	1SVR427060R0300	0.55 (1.21)
	10 A DC	CP-B 24/10.0	1SVR427060R1000	2.10 (4.63)
	20 A DC	CP-B 24/20.0	1SVR427060R2000	2.20 (4.85)

Ordering details - Extension unit

Rated voltage	Voltage range	Type	Catalog number	Weight (1 pce) kg (lb)
24 V DC	0-26.4 V DC	CP-B EXT.2	1SVR427065R0000	1.00 (2.20)

Example of application

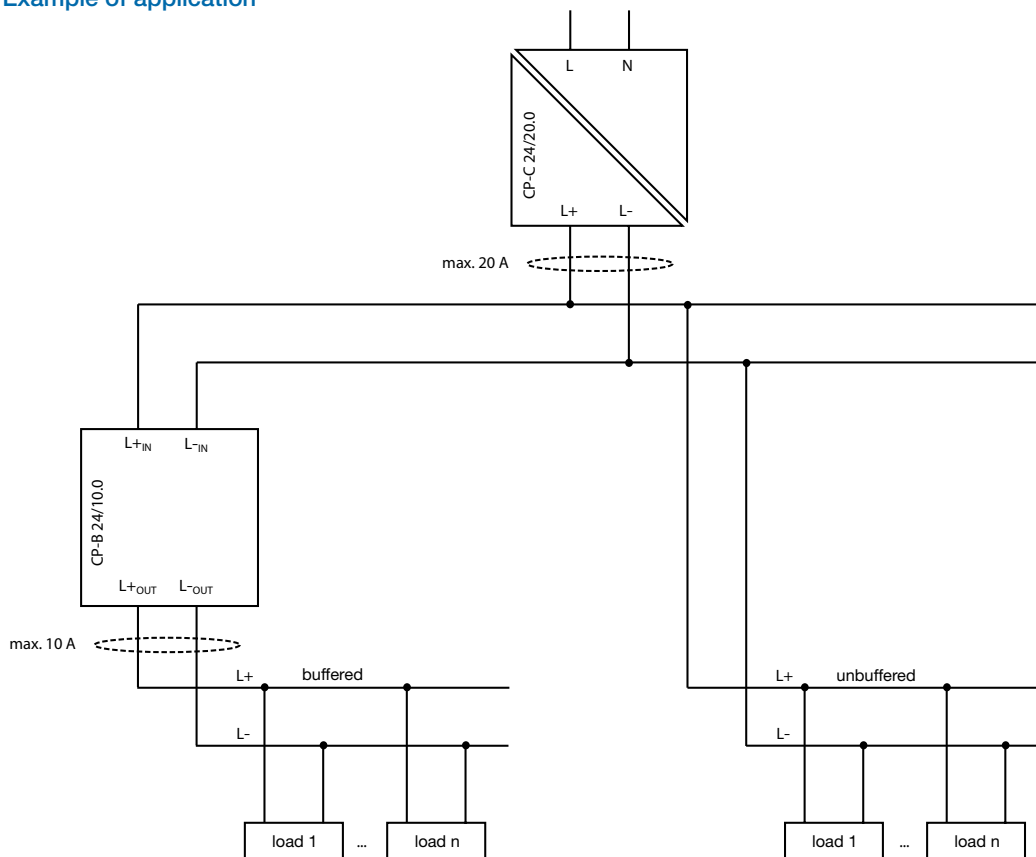

CP-B Range

Technical data

Data at Ta = 25 °C and rated values, unless otherwise indicated

Type		CP-B 24/3.0	CP-B 24/10.0	CP-B 24/20.0
Input circuit - Supply circuit			L+IN L-IN	
Rated input voltage U _{in}			24 V DC	
Input voltage range		23.7-26.4 V DC	23.9-27 V DC	23.4-27.4 V DC
Minimum charging potential		23.7 V DC	23.9 V DC	23.4 V DC
Rated input current		3 A DC	10 A DC	20 A DC
Inrush current limiting		50 A / 1 ms	35 A / 2 ms	35 A / 2 ms
Transient overvoltage protection		suppressor diode	varistor / suppressor diode	varistor / suppressor diode
Internal input fuse (apparatus protection, not accessible)		4 A slow acting	15 A (FK2)	30 A (FK2)
Kind of input	SHUT-DOWN	-	control input	control input
	rated voltage	-	24 V DC	24 V DC
	voltage range	-	6-45 V DC	6-45 V DC
Output circuit			L+OUT L-OUT L-OUT	
Rated output power		69 W	240 W	480 W
Rated output voltage U _{out}			24 V DC	
Output voltage (buffer mode)		23.0 V DC	23.2 V DC	23.2 V DC
Tolerance of the output voltage			+2..-10 %	
Rated output current I _r	Ta m 60 °C	3 A DC	10 A DC	20 A DC
Peak output current (fully loaded capacitors required)	Ta m 60 °C	6 A DC (min. 1.5 s)	20 A DC (10 A power supply + 10 A CP-B, min. 1.5 s)	40 A DC (min. 1.5 s)
Short-circuit protection (only via external fuse)			no continuous short-circuit stability	
Required external fuse		3.15 A slow acting	10 A slow acting	25 A slow acting
Power failure buffering time		load-dependent, min. 13 s at 100 % load	load-dependent, min. 38 s at 100 % load	load-dependent, min. 15 s at 100 % load
Overload protection			thermal protection	
Kind of output	INPUT OK		n/o contact	
	BUFFER STATUS	-	n/o contact	
	FAILURE	-	n/o contact	
Contact material			Ag + Au-clad	
Minimum switching voltage / Minimum switching current			5 V DC / 1 mA	
Maximum switching voltage / Maximum switching current		50 V AC / 1.0 A, 30 V DC / 0.5 A	125 V AC / 0.5 A, 60 V DC / 1 A	
Mechanical lifetime			5 x 10 ⁶ switching cycles	
Electrical lifetime			0.1 x 10 ⁶ switching cycles	
Maximum fuse rating to achieve short-circuit protection	n/o contact		1.0 A AC / 0.5 A DC	
General data				
Maximum internal power consumption		7 W	20 W	40 W
Power consumption with unloaded output		0.75 W	3 W	1.6 W
Energy storage (min.)		1000 Ws	10000 Ws	8000 Ws
Typical charging time at load current	100 %	65 s	134 s	135 s
	0 %	56 s	82 s	62 s
Typical buffering time at load current ¹⁾	100 %	13 s	38 s	15 s
	50 %	28 s	76 s	30 s
	25 %	66 s	140 s	60 s
	10 %	148 s	380 s	150 s
Efficiency			greater than 90 %	
Dimensions (W x H x D)	product dimensions	60 x 99 x 120 mm [2.36 x 3.90 x 4.72 in]	116 x 170 x 147 mm [4.57 x 6.69 x 5.79 in]	84 x 197 x 213 mm [3.31 x 7.76 x 8.39 in]
Weight	net weight	0.55 kg [1.21 lb]	2.1 kg [4.63 lb]	2.2 kg [4.85 lb]
Material	cover / housing shell		steel sheet powdered	
Mounting			DIN rail (IEC/EN 60715), snap-on mounting without any tool	
Mounting position			horizontal	
Minimum distance to other units	horizontal		not necessary	
	vertical		40 mm [1.58 in]	80 mm [3.15 in]
Pollution degree			2	
Degree of protection	housing / terminal		IP20	
Protection class (IEC/EN 61140)			III SELV / PELV (condition: power supply fulfills class III)	
Electrical connection - Input circuit / Output circuit		pull spring terminals	pull spring terminals	pluggable screw type terminals
Wire size	fine-strand with(out) wire end ferrule	0.08-1.0 mm ² (28-18 AWG)	0.08-1.5 mm ² (28-18 AWG)	0.2-4.0 mm ² (24-12 AWG)
	rigid	0.08-1.5 mm ² (28-16 AWG)	0.08-4.0 mm ² (28-16 AWG)	0.2-6.0 mm ² (24-10 AWG)
Stripping length		6.0 mm [0.24 in]		7.0 mm [0.28 in]
Signalling circuit				

CP-B Range

Technical data

Data at $T_a = 25\text{ °C}$ and rated values, unless otherwise indicated

Type		CP-B 24/3.0	CP-B 24/10.0	CP-B 24/20.0
Wire size	fine-strand with(out) wire end ferrule	0.08-1.0 mm ² (28-18 AWG)		0.14-1.0 mm ² (26-16 AWG)
	rigid	0.08-1.5 mm ² (28-16 AWG)		0.14-1.5 mm ² (28-16 AWG)
Stripping length		6.0 mm [0.24 in]		7.0 mm [0.28 in]
Environmental data				
Ambient temperature	operation	-40...+60 °C		-20...+60 °C
	storage	-40...+60 °C		-20...+60 °C
Standards				
Product standard		EN 50178		
Low Voltage Directive		2006/95/EC		
EMC Directive		2004/108/EC		
RoHS Directive		2002/95/EC		
Electrical safety		EN 50178, EN 60950, UL 508		

Electromagnetic compatibility

Interference immunity to		IEC/EN 61000-6-1, IEC/EN 61000-6-2		
electrostatic discharge	IEC/EN 61000-4-2	Level 3, 6 kV / 8 kV		
radiated, radio-frequency, electromagnetic field	IEC/EN 61000-4-3	Level 3, 10 V/m (27-1000 MHz) / Level 2, 3 V/m (1400-2700 MHz)		
electrical fast transient/burst	IEC/EN 61000-4-4	Level 3, 2(1) kV / 5 kHz		
surge	IEC/EN 61000-4-5	Level 1, 0.5 kV		
conducted disturbances, induced by radio-frequency fields	IEC/EN 61000-4-6	Level 3, 10 V (150 kHz-80 MHz)		
voltage dips, short interruptions and voltage variations	IEC/EN 61000-4-11	buffered by ultra-capacitors		
Interference emission		EN 61000-6-3, EN 61000-6-4		
high-frequency radiated	DIN EN 55011	B/C1		
high-frequency conducted	DIN EN 55011	B/C1		

$${}^1) \text{ buffering time } \approx \frac{\text{energy storage} \times 0.9}{\text{load current} \times 23.0 \text{ V}}$$

Approvals and marks* on page 11.2.

Technical diagrams

Output curve at $T_u = 25\text{ °C}$

dimensions in mm

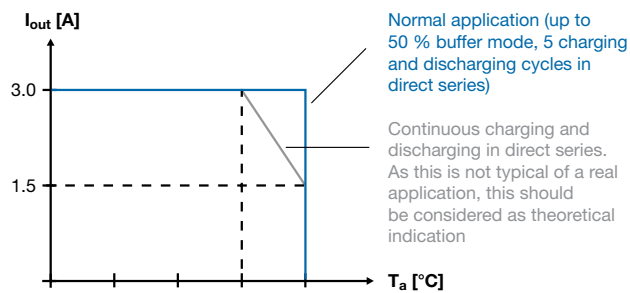

CP-B 24/3.0

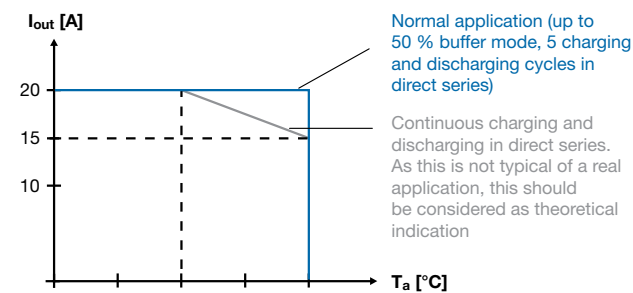

CP-B 24/20.0

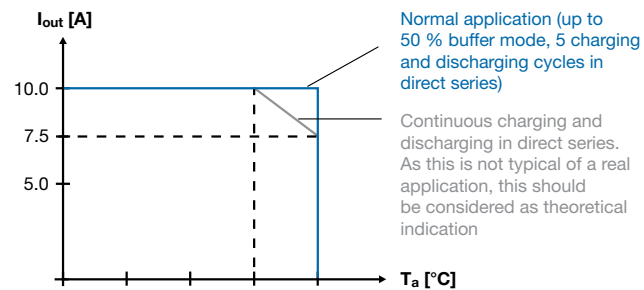

CP-B 24/10.0

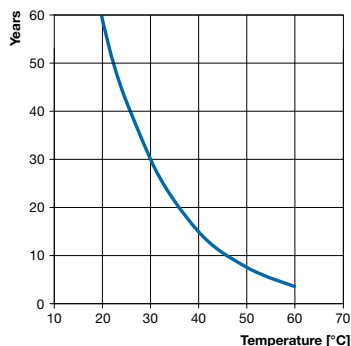

Capacitor's life span over temperature

Characteristic curve of the temperature at rated load

CP-B Range

Technical data

Data at Ta = 25 °C and rated values, unless otherwise indicated

Type		CP-B EXT 2.0
Extension circuit		EXT+ EXT+ EXT- EXT-
Voltage range		24 V DC
Rated current		0-26.4 V DC
Internal input fuse (apparatus protection, not accessible)		3 A DC
Short-circuit protection		4 A slow acting (PTC)
Overload protection		via internal 3 A fuse
		only in combination with CP-B 24/3.0 or CP-B 24/20.0
Indication of operational states		status information and fault messages of the buffer module apply
General data		
Power consumption without load		0.5 W
Energy storage (min.)		2000 Ws
Dimensions (W x H x D)		product dimensions 60 x 99 x 120 mm [2.36 x 3.90 x 4.72 in]
		packaging dimensions 85 x 220 x 170 mm [3.35 x 8.66 x 6.69 in]
Weight		net weight 1.00 kg (0.20 lb)
Material		cover / housing shell steel sheet powdered
Mounting		DIN rail (IEC/EN 60715), snap-on mounting without any tool
Mounting position		horizontal
Minimum distance to other units		horizontal not necessary
		vertical 40 mm [1.58 in]
Pollution degree		2
Degree of protection		housing / terminal IP20
Protection class (IEC/EN 61140)		III SELV / PELV (condition: power supply fulfills class III)
Electrical connection - Extension circuit		
Wire size		fine-strand with(out) wire end ferrule 0.08-1.0 mm ² (28-18 AWG)
		rigid 0.08-1.5 mm ² (28-16 AWG)
Stripping length		6.0 mm [0.24 in]
Signalling circuit		
Wire size		fine-strand with(out) wire end ferrule 0.08-1.0 mm ² (28-18 AWG)
		rigid 0.08-1.5 mm ² (28-16 AWG)
Stripping length		6.0 mm [0.24 in]
Environmental data		
Ambient temperature		operation -40...+60 °C
		storage -40...+60 °C
Standards		
Product standard		EN 50178
Low Voltage Directive		2006/95/EC
EMC Directive		2004/108/EC
RoHS Directive		2002/95/EC
Electrical safety		EN 50178, EN 60950, UL 508
Electromagnetic compatibility		
Interference immunity to		IEC/EN 61000-6-1, IEC/EN 61000-6-2
electrostatic discharge		IEC/EN 61000-4-2 Level 3, 6 kV / 8 kV
radiated, radio-frequency, electromagnetic field		IEC/EN 61000-4-3 Level 3, 10 V/m (27-1000 MHz) / Level 2, 3 V/m (1400-2700 MHz)
electrical fast transient/burst		IEC/EN 61000-4-4 Level 3, 2(1) kV / 5 kHz
surge		IEC/EN 61000-4-5 Level 1, 0.5 kV
conducted disturbances, induced by radio-frequency fields		IEC/EN 61000-4-6 Level 3, 10 V (150 kHz-80 MHz)
voltage dips, short interruptions and voltage variations		IEC/EN 61000-4-11 buffered by ultra-capacitors
Interference emission		EN 61000-6-3, EN 61000-6-4
high-frequency radiated		DIN EN 55011 B/C1
high-frequency conducted		DIN EN 55011 B/C1

Approvals and marks on page 11.3.

CP-B Range

Approximate dimensions

Dimensional drawings

dimensions in mm

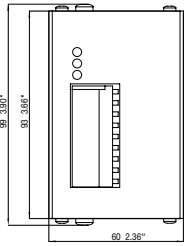

CP-B 24/3.0

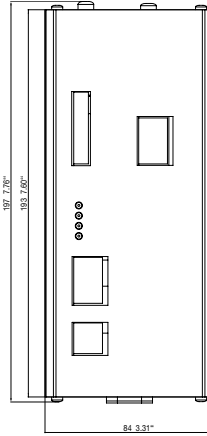
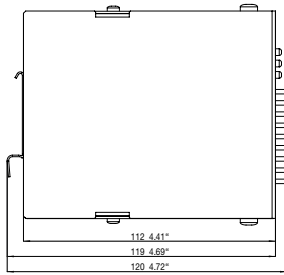

CP-B 24/20.0

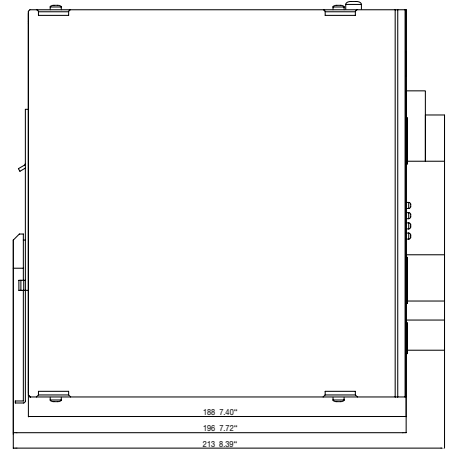

11

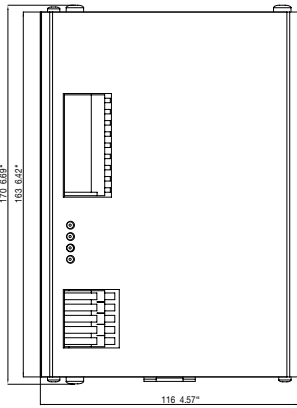

CP-B 24/10.0

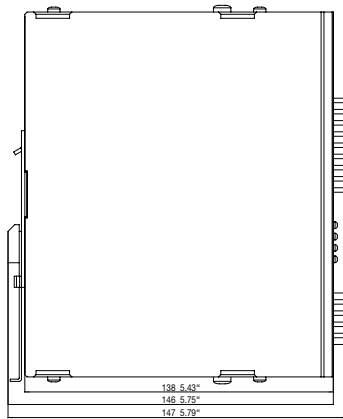

Type EPD24 Electronic protection devices



Electronic protection devices
EPD24

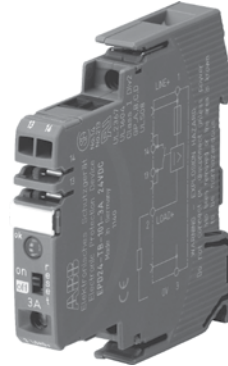

The protection devices EPD24 extend the ABB product range of Modular DIN rail components by electronic overcurrent protection modules for selective protection of 24V DC load circuits.

This protection is achieved by a combination of active electronic current limitation in the case of a short circuit and an overload deactivation from $1.1 \times I_n$ upwards.

If a fault occurs in a load circuit, the protection device EPD24 will detect this rapidly and reliably, disable the power output transistor and hence interrupt the current flow in the defective circuit. The maximum possible overcurrent is always limited to $1.3 \dots 1.8$ times the selected rated current. An activation of capacitive loads up to $20,000 \mu\text{F}$ is possible, deactivation only occurring in the case of overloads or short circuits. Selective deactivation of the defective current circuit means undefined error states and a complete system stop are prevented.

Features

- Selective load protection, one electronic tripping characteristic.
- Active current limitation for safe connection of capacitive loads up to $20,000 \mu\text{F}$ and on overload/short circuit.
- Current ratings $0.5 \text{ A} \dots 12 \text{ A}$.
- Reliable overload disconnection with $1.1 \times I_N$
- Manual ON/OFF button
- Clear status and failure indication through LED and integrated auxiliary contact.
- Integral fail-safe element adjusted to current rating.
- Width per unit only 12.5 mm.
- Rail mounting
- Ease of wiring through busbar LINE+ and 0 V as well as signal bars.
- UL and CSA-approvals allow international use of the devices.

Electronic protection devices

EPD24 Ordering details



EPD24-TB-101-3A

Ordering details

Rated current I_N A	bbn 40 16779 EAN	Type	Catalog number	Pkg qty	Weight (1 pce) kg (lb)
0.5	829960	EPD24-TB-101-0.5A	2CDE601101R2905	4	0.065 (1.433)
1	829984	EPD24-TB-101-1A	2CDE601101R2001	4	0.065 (1.433)
2	830003	EPD24-TB-101-2A	2CDE601101R2002	4	0.065 (1.433)
3	830027	EPD24-TB-101-3A	2CDE601101R2003	4	0.065 (1.433)
4	830041	EPD24-TB-101-4A	2CDE601101R2004	4	0.065 (1.433)
6	830065	EPD24-TB-101-6A	2CDE601101R2006	4	0.065 (1.433)
8	830089	EPD24-TB-101-8A	2CDE601101R2008	4	0.065 (1.433)
10	830102	EPD24-TB-101-10A	2CDE601101R2010	4	0.065 (1.433)
12	830126	EPD24-TB-101-12A	2CDE601101R2012	4	0.065 (1.433)

Ordering details

Description	bbn 40 16779 EAN	Type	Catalog number	Pkg qty	Weight (1 pce) kg (lb)
Busbars for LINE+ and 0 V, grey insulation, length 500 mm ¹⁾	830140	EPD-BB500	2CDE605100R0500	10	0.2 (0.441)
Signal Bars for aux. contacts, grey insula- tion, length 21 mm	830164	EPD-SB21	2CDE605200R0021	10	0.4 (0.882)

¹⁾ Max. load with one line entry $I_{max} = 50$ A (recommended: mid line entry)
Max. load with two line entries $I_{max} = 63$ A

Electronic protection devices

EPD24 Technical data

Wiring diagram

EPD24-TB-101

without signal input
with signal output F
(Single signal, N/O)

Operating condition: 13-14 closed

Fault condition: 13-14 open

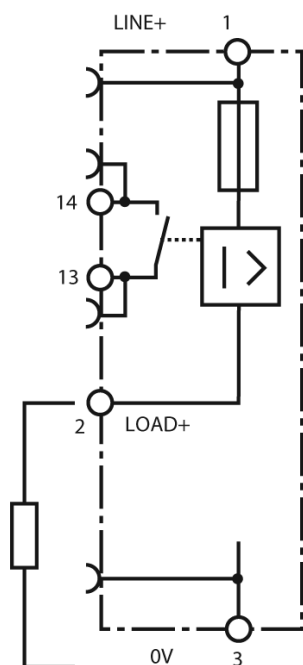

Operating data

Operating voltage UB:	24 V DC (18...32 V)
Current rating IN:	fixed current ratings: 0.5, 1, 2, 3, 4, 6, 8, 10, 12 A
Closed current IO:	ON condition: typically 20...30 mA depending on signal output
Status indication by means of:	multicolor LED: Green: unit is ON load circuit / Power-MOSFET is switched on Orange: in the event of overload or short circuit until electronic disconnection Red: unit electronically disconnected load circuit/Power-MOSFET OFF undervoltage (UB < 8 V) after switch-on till the end of the delay period OFF: manually switched off or device is dead potential-free auxiliary contact F ON/OFF/ condition of switch

Load circuit

Load output	Power-MOSFET switching output (high side switch)
Overload disconnection	typically $1.1 \times I_N$ ($1.05...1.35 \times I_N$)
Short-circuit current IK	active current limitation
Trip time	see time/current characteristics
For electronic disconnection	typically 3 s at $I_{Load} > 1.1 \times I_N$ typically 100 ms...3 s at $I_{Load} > 1.8 \times I_N$ (or $1.5 \times I_N/1.3 \times I_N$)
Temperature disconnection	internal temperature monitoring with electronic disconnection
Low voltage monitoring	with hysteresis, no reset required:
load output	load »OFF« at $UB < 8 V$
Starting delay tStart	typically 0.5 sec after every switch-on and after applying UB
Disconnection of load circuit	electronic disconnection
Free-wheeling circuit	suitable external free-wheeling circuit to be used with inductive load
Several load outputs must not be connected in parallel	

Signal output

Electrical data	potential-free auxiliary contact max. 30 V DC/0.5 A, min. 10 V DC/10 mA
ON condition LED green	voltage UB applied, switch is in ON position no overload, no short circuit
OFF condition LED off	device switched off (switch is in OFF position) no voltage UB applied
Fault condition LED orange	overload condition $> 1.1 \times I_N$ up to electronic disconnection
Fault condition LED red	electronic disconnection upon overload or short circuit Device switched off with control signal (switch is in ON position)
Aux. contact	single signal, make contact contact open, terminal 13-14
Fault	signal output fault conditions no operating voltage UB ON/OFF switch is in OFF position red LED lighted (electronic disconnection)

Electronic protection devices

EPD24 Technical data

General data

Fail-Safe element	backup fuse for EPD24 not required because of the integral redundant fail-safe element
Housing material	moulded
Mounting	symmetrical rail to EN 50022-35x7.5
Ambient temperature	0...+50 °C (without condensation, see EN 60204-1)
Storage temperature	-20...+70 °C
Humidity	96 hrs/95 % RH/40 °C to IEC 60068-2-78, test Cab. climate class 3K3 to EN 60721
Vibration	3 g, test to IEC 60068-2-6 test Fc
Degree of protection	housing: IP20 DIN 40050 terminals: IP20 DIN 40050
EMC	emission: EN 61000-6-3
(EMC directive, CE logo)	susceptibility: EN 61000-6-2
Isolations coordination (IEC 60934)	0.5 kV/pollution degree 2 reinforced insulation in operating area
Dielectric strength	max. 32 V DC (load circuit)
Isolation resistance (OFF condition)	n/a, only electronic disconnection
Approvals/Declarations of conformity	UL 2367 Solid State Overcurrent Protectors UL 1604, (class I, division 2, groups A, B, C, D) UL 508 CSA C22.2 No. 213 (class I, division 2) CSA C22.2 No. 142 CE logo
Dimensions (B x H x T)	12.5 x 80 x 83 mm
Weight	approx. 65 g
Terminals	Line+/LOAD+/0V
Screw terminals	M4
Max. cable cross section flexible with wire end ferrule w/wo plastic sleeve	0.5 – 10 mm ²
Multi-lead connection (2 identical cables) rigid/flexible	0.5 – 4 mm ²
Flexible with wire end ferrule without plastic sleeve	0.5 – 2.5 mm ²
Flexible with TWIN wire end ferrule with plastic sleeve	0.5 – 6 mm ²
Wire stripping length	10 mm
Tightening torque (EN 60934)	1.5 – 1.8 Nm
Terminals	aux. contacts
Screw terminals	M3
Max. cable cross section flexible with wire end ferrule w/wo plastic sleeve	0.25 - 2.5 mm ²
Wire stripping length	8 mm
Tightening torque (EN 60934)	0.5 Nm

Table 1: voltage drop, current limitation, max. load current

current rating I_N	typically voltage drop U_{ON} at I_N	active current limitation (typically)	max. load current at 100 % ON duty	
			$T_{ambient} = 40\text{ °C}$	$T_{ambient} = 40\text{ °C}$
0.5 A	70 mV	$1.8 \times I_N$	0.5 A	0.5 A
1 A	80 mV	$1.8 \times I_N$	1 A	1 A
2 A	130 mV	$1.8 \times I_N$	2 A	2 A
3 A	80 mV	$1.8 \times I_N$	3 A	3 A
4 A	100 mV	$1.8 \times I_N$	4 A	4 A
6 A	130 mV	$1.8 \times I_N$	6 A	5 A
8 A	120 mV	$1.5 \times I_N$	8 A	7 A
10 A	150 mV	$1.5 \times I_N$	10 A	9 A
12 A	180 mV	$1.3 \times I_N$	12 A	10.8 A

Attention: when mounted side-by-side without convection the ERD24 should not carry more than 80 % of its rated load with 100 % ON duty due to thermal effects.

Electronic protection devices

EPD24 Technical data

Time/Current characteristic curve ($T_{\text{ambient}} = 25\text{ }^{\circ}\text{C}$)

- The trip time is typically 3 s in the range between $1.1 \times I_N$ and $1.8 \times I_N$ ¹⁾.
- Electronic current limitation occurs at typically $1.8 \times I_N$ ¹⁾ which means that under all overload conditions (independent of the power supply and the resistance of the load circuit) the max. overload before disconnection will not exceed $1.8 \times I_N$ times the current rating. Trip time is between 100 ms and 3 sec (depending on overload or at short circuit).
- Without this current limitation a considerably higher overload current would flow in the event of an overload or short circuit.

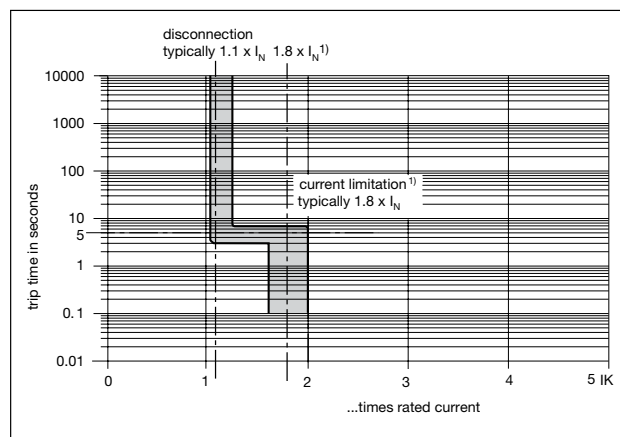

¹⁾ Current limitation typically $1.8 \times I_N$ at $I_N = 0.5\text{ A} \dots 6\text{ A}$
 Current limitation typically $1.5 \times I_N$ at $I_N = 8\text{ A}$ or 10 A
 Current limitation typically $1.3 \times I_N$ at $I_N = 12\text{ A}$

Maximum cable lengths

EPD24 reliably trips from $0\text{ }\Omega$ up to max. circuit resistance R_{max} .

Calculation of R_{max}

Selected rating I_N (A)	3	6
Operating voltage U_s (V DC) (= 80 % of 24 V) ²⁾	19.2	19.2
Trip current $I_{\text{tr}} = 1.25 \times I_N$ (A) (EPD24 trips after 3 s)	3.75	7.50
$R_{\text{max}} (\Omega) = (U_s / I_{\text{tr}}) - 0.050$	5.07	2.51

²⁾ Voltage drop of EPD24 and tolerance of trip point (typically $1.1 \times I_N = 1.05 \dots 1.35 \times I_N$) have been taken into account

Selection table for the incoming cable lengths with different cable cross-sections

Cable cross section A (mm ²)	0.14	0.25	0.34	0.5	0.75	1.00	1.50
Cable length L (m) (= single length)	cable resistance (Ω) = $(\rho_c \times 2 \times L) / A$³⁾						
5	1.27	0.71	0.52	0.36	0.24	0.18	0.12
10	2.54	1.42	1.05	0.71	0.47	0.36	0.24
15	3.81	2.14	1.57	1.07	0.71	0.53	0.36
20	5.09	2.85	2.09	1.42	0.95	0.71	0.47
25	6.36	3.56	2.62	1.78	1.19	0.89	0.59
30	7.63	4.27	3.14	2.14	1.42	1.07	0.71
35	8.90	4.98	3.66	2.49	1.66	1.25	0.83
40	10.17	5.70	4.19	2.85	1.90	1.42	0.95
45	11.44	6.41	4.71	3.20	2.14	1.60	1.07
50	12.71	7.12	5.24	3.56	2.37	1.78	1.19
75	19.07	10.68	7.85	5.34	3.56	2.67	1.78
100	25.34	14.24	10.47	7.12	4.75	3.56	2.37
125	31.79	17.80	13.09	8.90	5.93	4.45	2.97
150	38.14	21.36	15.71	10.68	7.12	5.34	3.56
175	44.50	24.92	18.32	12.46	8.31	6.23	4.15
200	50.86	28.48	20.94	14.24	9.49	7.12	4.75
225	57.21	32.04	23.56	16.02	10.68	8.01	5.34
250	63.57	35.60	26.18	17.80	11.87	8.90	5.93

³⁾ Resistivity of copper $\rho_c = 0.0178 (\Omega \times \text{mm}^2) / \text{m}$

Example 3: mixed wiring: (Control cabinet --- sensor/actuator level)
 $R_1 = 40\text{ m}$ for 1.5 mm^2 and $R_2 = 5\text{ m}$ for 0.25 mm^2 :
 $R_1 = 0.95\text{ }\Omega$, $R_2 = 0.71\text{ }\Omega$, total ($R_1 + R_2$) = **1.66 Ω**

Example 1: max. length for 1.5 mm^2 and 3 A: **214 m**

Example 2: max. length for 1.5 mm^2 and 6 A: **106 m**

Electronic protection devices

EPD24 Approvals, safety instructions

Please note

The user must ensure that the cable cross sections of the relevant load circuit are suitable for the current rating of the EPD24 used. Automatic start-up of machinery after shut down must be prevented (Machinery Directive 98/37/EG and EN 60204-1). In the event of a short circuit or overload the load circuit will be disconnected electronically by the EPD24.

Information on UL approvals/CSA approvals



UL1604
UL File # E 339238



CSA C22.2 No. 213 (Class I, Division 2)
CSA File # 2305929

Operating Temperature Code T5

- This equipment is suitable for use in Class I, Division 2, Groups A, B, C and D or non-hazardous locations only

WARNING:

- Exposure to some chemicals may degrade the sealing properties of materials used in the following device: relay

Sealant Material:

Generic Name: Modified diglycidyl ether of bisphenol A
Supplier: Fine Polymers Corporation
Type: Epi Fine 4616L-160PK

Casing Material:

Generic Name: Liquid Crystal Polymer
Supplier: Sumitomo Chemical
Type: E4008, E4009, or E6008

11

RECOMMENDATION:

- Periodically inspect the device named above for any degradation of properties and replace if degradation is found

WARNING – EXPLOSION HAZARD:

- Do not disconnect equipment unless power has been removed or the area is known to be non-hazardous
- Substitution of any components may impair suitability for Class I, Division 2



UL2367
Non-hazardous use - UL File # E 339236



UL 508
Non-hazardous use - UL File # E 149922



CSA C22.2 No. 14
CSA C22.2 No. 142 - CSA File # E 2305929

Class 2

Meets requirement for Class 2 current limitation (EPD24 ... -0,5 A/1 A/2 A/3 A)

Electronic protection devices

EPD24 Installation guidelines

The EPD24 features an integral power distribution system.

The following wiring modes are possible with various pluggable current and signal busbars:

- LINE+ (24 V DC)
- 0 V

Caution: The electronic devices EPD24 require a 0 V connection

- Auxiliary contacts

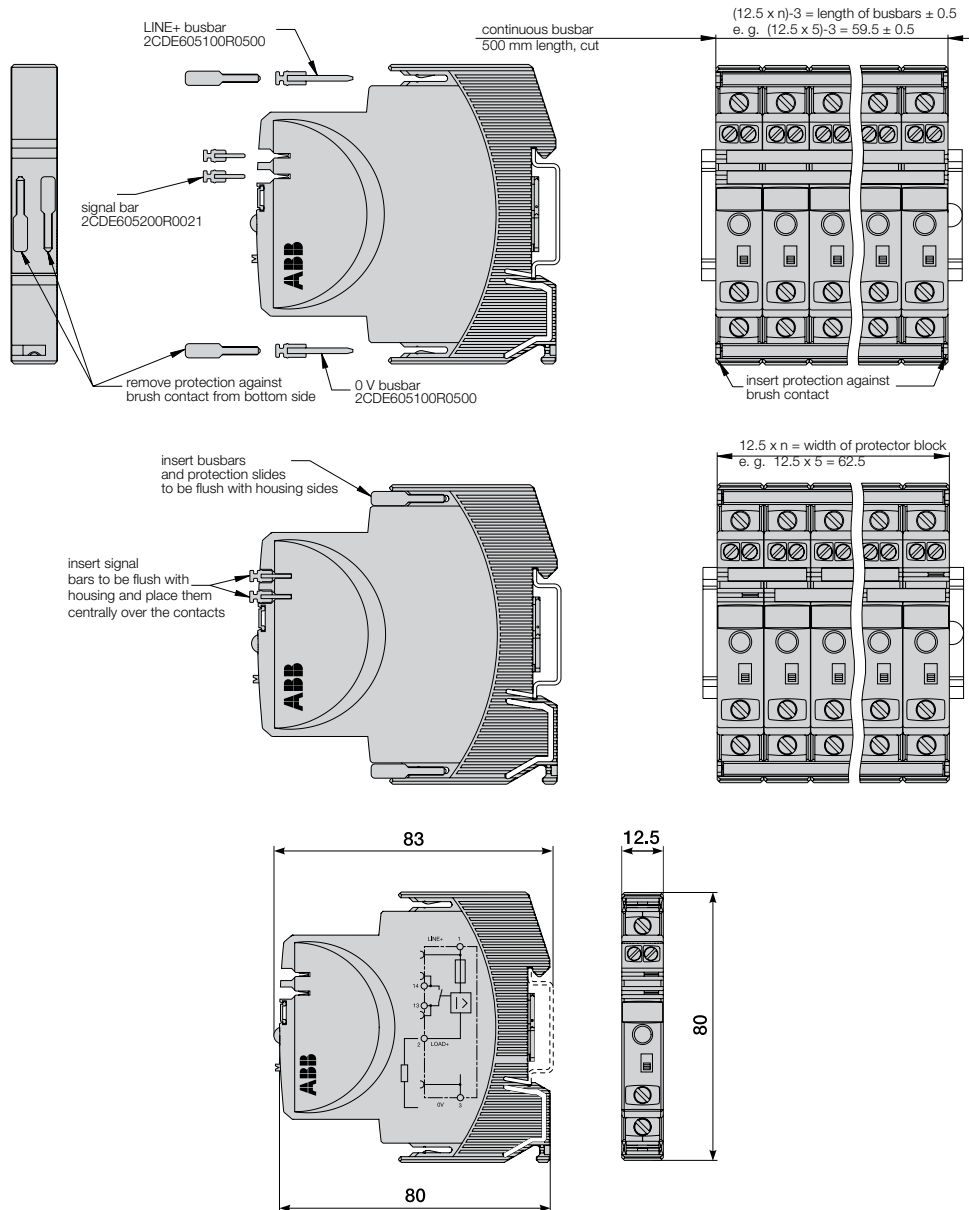

Mounting procedure

Before wiring insert busbars into protector block. A maximum of 10 connection cycles are permissible using connecting busbars.

Recommendation

After 10 units the busbars should be interrupted and receive a new entry live.

Table of length for busbars

(Catalog number 2CDE605100R0500)

No. of units	2	3	4	5	6	7	8	9	10
Length of busbar (mm) ± 0.5 mm	22	34.5	47	59.5	72	84.5	97	109.5	122